

Part number:

HYDROMA

HYDRAULICKÉ SYSTÉMY

**HIDROMA
SISTEMS**

UKŁADY HYDRAULICZNE

HYDROMA

ГИДРАВЛИЧЕСКИЕ СИСТЕМЫ

GHP2

COME ORDINARE / HOW TO ORDER

GHP2	TIPO TYPE	ROTAZIONE ROTATION	TAGLIA SIZE	ALBERO* SHAFT*	PORTE* PORTS*	GUARNIZIONI* SEALS*	OPZIONI* OPTIONS*	DRENAGGIO* DRAIN*
	omit	D DESTRA CLOCKWISE	6			Guarnizioni / Seals omit (T range = -10°C + 80°C) V H ...	Opzioni / Options TR T KA OR*** ...	Drenaggio / Drain E0 = drenaggio interno/internal drain E1 = drenaggio esterno/external drain G1/4 ****E2 = drenaggio esterno/external drain 9/16-18 UNF E3 = drenaggio esterno/external drain G3/8 (solo per opzione VM/only for VM options) ****E4 = drenaggio esterno/external drain 7/16-20 UNF (solo per rotazione R e porte KA/only for R rotation and KA ports)
	A	S SINISTRA COUNTER CLOCKWISE	9					
	A3		10					
	BK1	R** REVERSIBILE REVERSIBLE	12					
	BK2		13					
	BK4		16					
	BK7		20					
			22					
			25					
			30					
			34					
			37					
			40					
			50					

(*) = campi da specificare se diversi dallo standard "tipo pompa" / to be specified if different from standard pump type
 (**) = la rotazione reversibile R è disponibile per tutte le taglie indicate (eccetto 6) / R rotation is available for all listed displacements (except 6)
 (***) = solo per tipi pompa A e BK1 / only for A and BK1 pump types
 (****) = Le porte di drenaggio sono lavorate secondo la specifica SAE J1926/1 (ISO 11926-1) relativa a porte filettate con tenuta O-ring / Drain ports are machined in compliance with threaded port with O-ring seal in truncated housing SAE J1926/1 (ISO 11926-1)

Tipi Pompa Standard / Pump Standard Types

omit	= flangia europea + albero T0 + porte E + guarnizioni standard / european flange + shaft T0 + ports E + standard seals
A	= flangia A + albero C1 + porte FA + guarnizioni standard / flange A + shaft C1 + ports FA + standard seals
A3	= flangia A3 + albero C3 + porte FA + guarnizioni standard / flange A3 + shaft C3 + ports FA + standard seals
BK1	= flangia BK1 + albero T1 + porte D + guarnizioni standard / flange BK1 + shaft T1 + ports D + standard seals
BK2	= flangia BK2 + albero T2 + porte D + guarnizioni standard / flange BK2 + shaft T2 + ports D + standard seals
BK4	= flangia BK4 + albero T2 + porte D + guarnizioni standard / flange BK4 + shaft T2 + ports D + standard seals
BK7	= flangia BK7 + albero G0 + porte D + guarnizioni standard / flange BK7 + shaft G0 + ports D + standard seals

Esempi / Examples:

GHP2-D-6	= pompa destra, 4.5 cc/rev, flangia europea, albero conico 1:8, porte flangiate tipo E, guarnizioni standard clockwise rotation, 4.5 cc/rev, european flange, 1:8 tapered shaft, flanged ports E type, standard seals
GHP2A-D-6-KA	= pompa destra, 4.5 cc/rev, flangia SAE A 2 fori, albero cilindrico, guarnizioni standard, porte filettate UNF sul coperchio (KA) clockwise rotation, 4.5 cc/rev, SAE A 2 bolt flange, cylindrical shaft, standard seals, UNF threaded rear ports (KA)
GHP2BK2-D-6-E	= pompa destra, 4.5 cc/rev, flangia tedesca quadrata, albero conico 1:5, porte flangiate (E), guarnizioni standard clockwise rotation, 4.5 cc/rev, german square flange, 1:5 tapered shaft, european flanged ports (E), standard seals
GHP2A-D-6-OR	= pompa destra, 4.5 cc/rev, flangia SAE a 2 fori, albero cilindrico C1, porte filettate FA, guarnizioni standard, guarnizione OR sul colletto clockwise rotation, 4.5 cc/rev, SAE A 2 bolt flange, cylindrical shaft C1, threaded ports FA, standard seal, OR seal on pilot

LE TAVOLE DI PRODOTTO RAPPRESENTANO I TIPI POMPA STANDARD PER MARZOCCHI POMPE. LE TAVOLE SINOTTICHE DI FLANGE, ALBERI E PORTE HANNO LO SCOPO DI RAPPRESENTARE TUTTE LE POSSIBILI CONFIGURAZIONI DI PRODOTTO. PER MAGGIORI DETTAGLI SULLE DISPONIBILITÀ E CONDIZIONI DI FORNITURA, CONSIGLIAMO DI INTERPELLARE IL NOSTRO UFFICIO TECNICO-COMMERCIALE.

THE PRODUCT DATA SHEETS SHOW OUR STANDARD MODEL TYPES. THE SYNOPSIS TABLES FOR FLANGES, SHAFTS AND PORTS SHOW ALL THE POSSIBLE CONFIGURATIONS. FOR FURTHER DETAILS ABOUT THE AVAILABILITY OF EACH CONFIGURATION PLEASE CONTACT OUR SALES AND TECHNICAL DEPT.

GHP2

Parti accessorie a corredo della pompa standard: linguetta a disco (codice 522057), dado M12x1.5 (codice 523016), rosetta elastica spaccata (codice 523005).
 Porte standard: filetti M6 profondità utile 13 mm, filetti M8 profondità utile 17 mm.
 Disponibile su richiesta albero conico con linguetta a disco di spessore 3,2 mm ("T3").

Accessories supplied with the standard pump: woodruff key (code 522057), M12x1.5 exagonal nut (code 523016), washer (code 523005).
 Standard ports: M6 threads depth 13 mm, M8 threads depth 17 mm.
 The tapered shaft is also available with 3,2 mm key ("T3").

MANDATA
OUTLET

ASPIRAZIONE
INLET

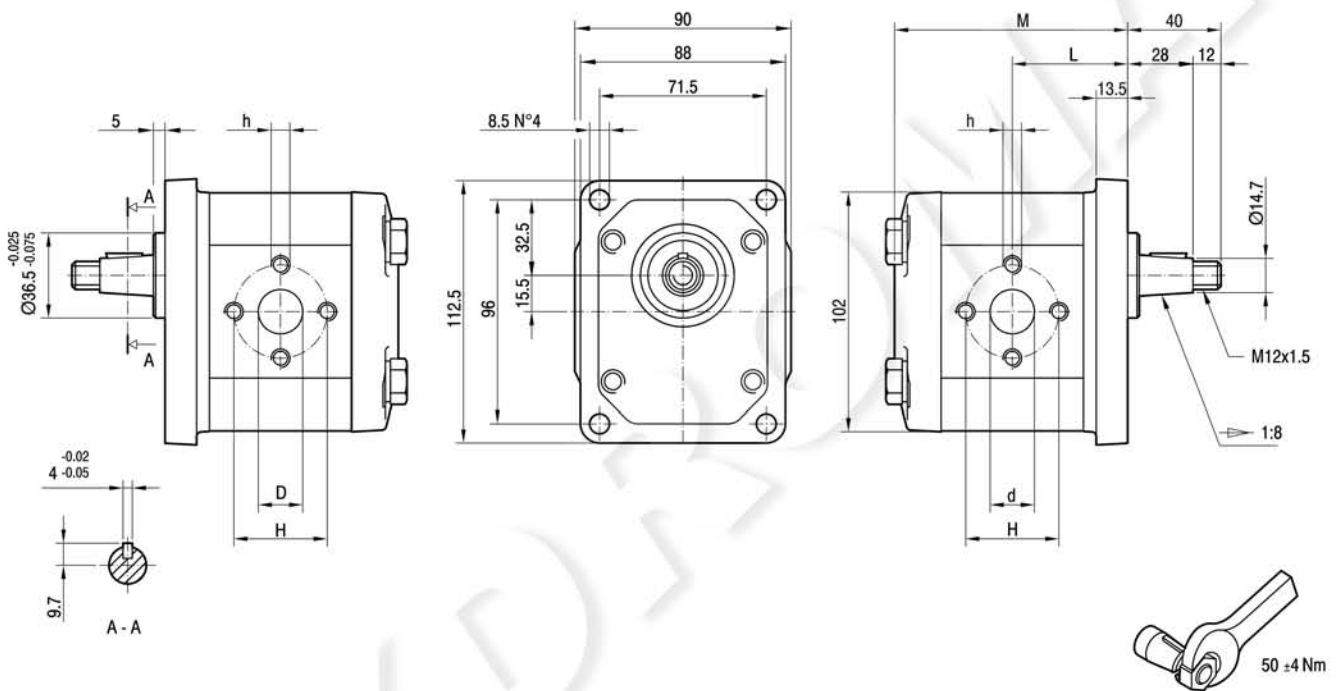

TIPO TYPE	CILINDRATA DISPLACEMENT	PORTATA a 1500 giri/min FLOW at 1500 rev/min	PRESSIONI MASSIME MAX PRESSURE			VELOCITÀ MASSIMA MAX SPEED	DIMENSIONI DIMENSIONS					
			P ₁	P ₂	P ₃		L	M	d	D	h	H
	cm ³ /giro [cm ³ /rev]	litri/min [litres/min]	bar	bar	bar	giri/min [rpm]	mm	mm	mm	mm	mm	mm
GHP2-D-6	4,5	6,4	280	295	310	4000	45,5	92	13	13	M6	30
GHP2-D-9	6,4	9,1	280	295	310	4000	47	95	13	13	M6	30
GHP2-D-10	7,0	10,0	280	295	310	4000	47,5	96	13	13	M8	40
GHP2-D-12	8,3	11,8	280	295	310	3500	48,5	98	13	13	M8	40
GHP2-D-13	9,6	13,7	280	295	310	3000	49,5	100	13	13	M8	40
GHP2-D-16	11,5	16,4	280	295	310	4000	51	103	19	13	M8	40
GHP2-D-20	14,1	20,1	260	275	290	4000	53	107	19	13	M8	40
GHP2-D-22	16,0	22,8	260	275	290	4000	54,5	110	19	13	M8	40
GHP2-D-25	17,9	25,5	260	275	290	3600	56	113	19	13	M8	40
GHP2-D-30	21,1	30,1	230	245	260	3200	58,5	118	19	19	M8	40
GHP2-D-34	23,7	33,7	230	245	260	3000	60,5	122	19	19	M8	40
GHP2-D-37	25,5	36,4	210	225	240	2800	62	125	19	19	M8	40
GHP2-D-40	28,2	40,1	200	215	230	2500	64	129	19	19	M8	40
GHP2-D-50	35,2	50,2	160	175	190	2500	69,5	140	21	19	M8	40

GHP2

FLANGE / FLANGES

ALBERI / SHAFTS

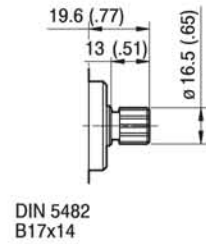
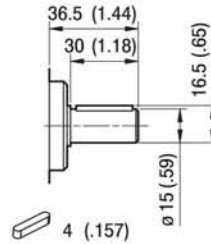
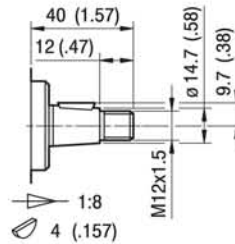
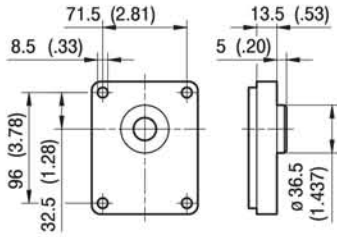

DIN 5482
B17x14

T0

C0

S0

Coppia Max
Max Torque 145 Nm

Coppia Max
Max Torque 125 Nm

Coppia Max
Max Torque 130 Nm

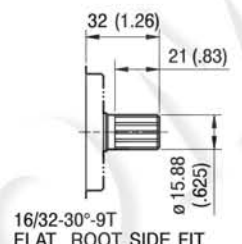
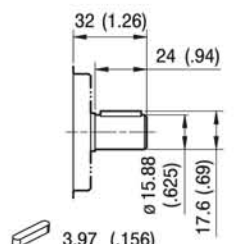
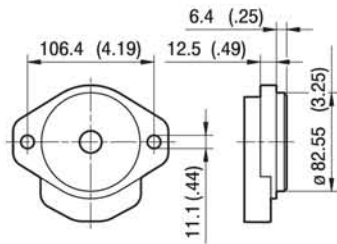

16/32-30°-9T
FLAT ROOT SIDE FIT

A

C1

S1

Coppia Max
Max Torque 105 Nm

Coppia Max
Max Torque 110 Nm

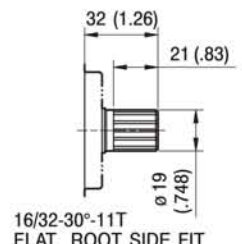
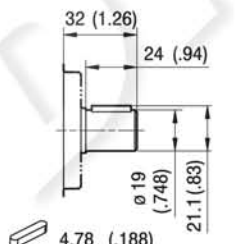

16/32-30°-11T
FLAT ROOT SIDE FIT

C2

S2

Coppia Max
Max Torque 150 Nm

Coppia Max
Max Torque 230 Nm

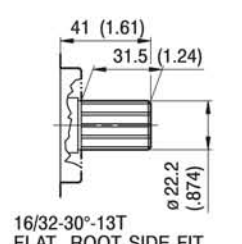
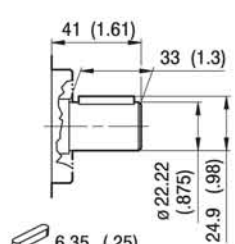
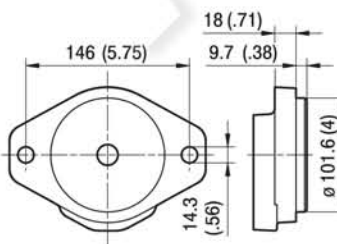

16/32-30°-13T
FLAT ROOT SIDE FIT

A3

C3

S5

Coppia Max
Max Torque 130 Nm

Coppia Max
Max Torque 130 Nm

GHP2

PORTE / PORTS

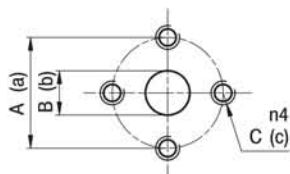

E

TIPO TYPE	ASPIRAZIONE INLET			MANDATA OUTLET		
	A	B	C	a	b	c
GHP2...6 ÷ GHP2...9	30	13	M6	30	13	M6
GHP2...10 ÷ GHP2...13	40	13	M8	40	13	M8
GHP2...16 ÷ GHP2...25	40	19	M8	40	13	M8
GHP2...30 ÷ GHP2...40	40	19	M8	40	19	M8
GHP2...50	40	21	M8	40	19	M8

I valori delle coppie di serraggio delle viti presenti nel kit raccordo sono indicate a pag 55 (capitolo accessori)
Tightening torques of the fittings screws are specified on page 55 (accessories section)

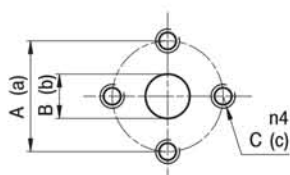

EP

TIPO TYPE	ASPIRAZIONE INLET			MANDATA OUTLET		
	A	B	C	a	b	c
GHP2...6	40	13	M8	30	13	M6
GHP2...10 ÷ GHP2...13	30	13	M6	30	13	M6
GHP2...16 ÷ GHP2...40	40	19	M8	30	13	M6
GHP2...50	40	21	M8	30	19	M6

I valori delle coppie di serraggio delle viti presenti nel kit raccordo sono indicate a pag 55 (capitolo accessori)
Tightening torques of the fittings screws are specified on page 55 (accessories section)

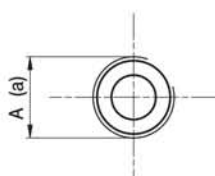

FG

TIPO TYPE	ASPIRAZIONE INLET	MANDATA OUTLET
	A	a
GHP2...6 ÷ GHP2...16	G1/2	G1/2
GHP2...20 ÷ GHP2...40	G3/4	G1/2

Raccordo G1/2 coppia di serraggio massima 50 Nm. Raccordo G3/4 coppia di serraggio massima 60 Nm.
Consigliamo di richiedere conferma al fornitore del raccordo.
Tightening torques for G1/2 fitting: 50 Nm. Tightening torques for G3/4 fitting: 60 Nm. Please check with the fittings suppliers.

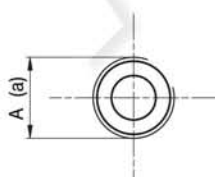

FC

TIPO TYPE	ASPIRAZIONE INLET	MANDATA OUTLET
	A	a
GHP2...6 ÷ GHP2...16	Rc1/2	Rc1/2
GHP2...20 ÷ GHP2...40	Rc3/4	Rc1/2

Raccordo Rc1/2 coppia di serraggio massima 50 Nm. Raccordo Rc3/4 coppia di serraggio massima 60 Nm.
Consigliamo di richiedere conferma al fornitore del raccordo.
Tightening torques for Rc1/2 fitting: 50 Nm. Tightening torques for Rc3/4 fitting: 60 Nm. Please check with the fittings suppliers.



Potenza assorbita Absorbed power P [kW]
 Momento torcente assorbito Absorbed torque M [Nm]
 Velocità di rotazione Drive speed n [giri/min] [rpm]

