

Part number:

**HYDROMA**

HYDRAULICKÉ SYSTÉMY

**HIDROMA  
SYSTEMS**

UKŁADY HYDRAULICZNE

**HYDROMA**

ГИДРАВЛИЧЕСКИЕ СИСТЕМЫ

# FRF-RFC

## RETURN FILTERS

### MATERIALS

Head and cover: Aluminium alloy

Diffusor: Zinc plated steel

Element support:

Polyamide (aluminium alloy for FRF3+ and FRF4+)

Magnetic core: Synthesized magnetic material

Seals: NBR Nitrile

(FKM Fluoroelastomer on request)

Indicator housing: Brass

### PRESSURE

Max. working: 1 MPa (10 bar)

Collapse, differential for the filter element (ISO 2941): 1 MPa (10 bar)

### BYPASS VALVE

Setting: 170 kPa (1,7 bar)  $\pm$  10%

### WORKING TEMPERATURE

From -25° to +110° C

### COMPATIBILITY (ISO 2943)

Full with fluids: HH-HL-HM-HV-HTG

(according to ISO 6743/4)

For fluids different than the above mentioned,  
please contact our Customer Service.

### HYDRAULIC DIAGRAM

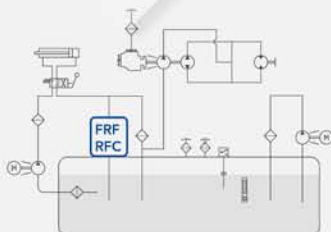

Is this datasheet the latest release? Please check on our website.

# FRF

## RETURN FILTERS

### ORDERING AND OPTION CHART

F	R	F	COMPLETE FILTER FAMILY					FILTER ELEMENT FAMILY	E	R	F
			SIZE & LENGTH	11	12	13	14	SIZE & LENGTH			
			PORT TYPE								
			B = BSP thread	B	B	B	B				
			A = BSP thread, double port (only A08)	A	A	A	A				
			N = NPT thread	N	N	N	N				
			S = SAE thread	S	S	S	S				
			PORT SIZE								
			06 = 3/4"	06	06	06	06				
			08 = 1"	08	08	08	08				
			10 = 1" 1/4	10	10	10	10				
		F	BYPASS VALVE								
			F = 170 kPa (1,7 bar)	F	F	F	F				
			SEALS					SEALS			
			N = NBR Nitrile	N	N	N	N				
			F = FKM Fluoroelastomer	F	F	F	F				
			FILTER MEDIA					FILTER MEDIA			
			FA = fibreglass 5 µm(c) β>1.000	FA	FA	FA	FA				
			FB = fibreglass 7 µm(c) β>1.000	FB	FB	FB	FB				
			FC = fibreglass 12 µm(c) β>1.000	FC	FC	FC	FC				
			FD = fibreglass 21 µm(c) β>1.000	FD	FD	FD	FD				
			CC = impregnated cellulose 10 µm β>2	CC	CC	CC	CC				
			ME = wire mesh 60 µm	ME	ME	ME	ME				
			CLOGGING INDICATOR								
			05 = nr. 2 x 1/8" ports, plugged	05	05	05	05				
			30 = manometer, scale 0 - 600 kPa (0 - 6 bar)	30	30	30	30				
			P4 = SPDT, pressure switch	P4	P4	P4	P4				
			ACCESSORIES								
			W = without accessory	W	W	W	W				
			F = with diffusor	F	F	F	F				
			ACCESSORIES								
			W = without accessory	W	W	W	W				
			M = magnetic core	M	M	M	M				

# RFC

## RETURN FILTERS

### ORDERING AND OPTION CHART

R	F	C	COMPLETE FILTER FAMILY					FILTER ELEMENT FAMILY	C	R	C
			SIZE & LENGTH	110	120	130	140	SIZE & LENGTH			
			FILTER MEDIA					FILTER MEDIA			
			FT = fibreglass 5 µm(c) β>1.000	FT	FT	FT	FT				
			FC = fibreglass 7 µm(c) β>1.000	FC	FC	FC	FC				
			FD = fibreglass 12 µm(c) β>1.000	FD	FD	FD	FD				
			FV = fibreglass 21 µm(c) β>1.000	FV	FV	FV	FV				
			CD = impregnated cellulose 10 µm β>2	CD	CD	CD	CD				
			MS = wire mesh 60 µm	MS	MS	MS	MS				
			SEALS					SEALS			
			1 = NBR Nitrile	1	1	1	1				
			2 = FKM Fluoroelastomer	2	2	2	2				
F			BYPASS VALVE								
			F = 170 kPa (1,7 bar)	F	F	F	F				
			PORT TYPE								
			B = BSP thread	B	B	B	B				
			N = NPT thread	N	N	N	N				
			S = SAE thread	S	S	S	S				
			PORT SIZE								
			4 = 3/4"	4	4	4	4				
			5 = 1"	5	5	5	5				
			6 = 1" 1/4	6	6	6	6				
			CLOGGING INDICATOR								
			05 = nr. 2 x 1/8" ports, plugged	05	05	05	05				
			30 = manometer, scale 0 - 600 kPa (0 - 6 bar)	30	30	30	30				
			P4 = SPDT, pressure switch	P4	P4	P4	P4				
			ACCESSORIES								
			S = without accessory	S	S	S	S				
			D = with diffusor	D	D	D	D				
			ACCESSORIES								
			S = without accessory	S	S	S	S				
			M = magnetic core	M	M	M	M				

# FRF

## RETURN FILTERS

### ORDERING AND OPTION CHART

F	R	F	COMPLETE FILTER FAMILY				FILTER ELEMENT FAMILY	E	R	F
			SIZE & LENGTH	22	23	24	SIZE & LENGTH			
			PORT TYPE							
			B = BSP thread	B	B	B				
			A = BSP thread, double port (only AD1)	A	A	A				
			N = NPT thread	N	N	N				
			S = SAE thread	S	S	S				
			F = SAE flange 3000 psi	F	F	F				
			P = SAE flange 3000 psi, double port	P	P	P				
			PORT SIZE							
			12 = 1" 1/2 (P12= 1"1/2 SAE+ 1" 1/2 BSP)	12	12	12				
			D1 = 1" 1/2 + 1" 1/4 (only AD1)	D1	D1	D1				
		F	BYPASS VALVE							
			F = 170 kPa (1,7 bar)	F	F	F				
			SEALS				SEALS			
			N = NBR Nitrile	N	N	N				
			F = FKM Fluoroelastomer	F	F	F				
			FILTER MEDIA				FILTER MEDIA			
			FA = fibreglass 5 µm(c) β>1.000	FA	FA	FA				
			FB = fibreglass 7 µm(c) β>1.000	FB	FB	FB				
			FC = fibreglass 12 µm(c) β>1.000	FC	FC	FC				
			FD = fibreglass 21 µm(c) β>1.000	FD	FD	FD				
			CC = impregnated cellulose 10 µm β>2	CC	CC	CC				
			ME = wire mesh 60 µm	ME	ME	ME				
			CLOGGING INDICATOR**							
			05 = nr. 2 x 1/8" ports, plugged	05	05	05				
			30 = manometer, scale 0 - 600 kPa (0 - 6 bar)	30	30	30				
			P4 = SPDT, pressure switch	P4	P4	P4				
			03 = port for differential indicator, plugged	03	03	03				
			5B = visual differential 130 kPa (1,3 bar)	5B	5B	5B				
			6B = electrical differential 130 kPa (1,3 bar)	6B	6B	6B				
			7B = indicator 6B with LED	7B	7B	7B				
			T0 = elect. diff. 130 kPa (1,3 bar) with thermostat 30°C	T0	T0	T0				
			ACCESSORIES							
			W = without accessory	W	W	W				
			F = with diffusor	F	F	F				
			ACCESSORIES							
			W = without accessory	W	W	W				
			M = magnetic core	M	M	M				

# RFC

## RETURN FILTERS

### ORDERING AND OPTION CHART

R	F	C	COMPLETE FILTER FAMILY				FILTER ELEMENT FAMILY	C	R	C
			SIZE & LENGTH	220	230	240	SIZE & LENGTH			
			FILTER MEDIA				FILTER MEDIA			
			FT = fibreglass 5 µm(c) β>1.000	FT	FT	FT				
			FC = fibreglass 7 µm(c) β>1.000	FC	FC	FC				
			FD = fibreglass 12 µm(c) β>1.000	FD	FD	FD				
			FV = fibreglass 21 µm(c) β>1.000	FV	FV	FV				
			CD = impregnated cellulose 10 µm β>2	CD	CD	CD				
			MS = wire mesh 60 µm	MS	MS	MS				
			SEALS				SEALS			
			1 = NBR Nitrile	1	1	1				
			2 = FKM Fluoroelastomer	2	2	2				
F			BYPASS VALVE							
			F = 170 kPa (1,7 bar)	F	F	F				
			PORT TYPE							
			B = BSP thread	B	B	B				
			N = NPT thread	N	N	N				
			S = SAE thread	S	S	S				
			F = SAE flange 3000 psi	F	F	F				
			PORT SIZE							
			7 = 1" 1/2	7	7	7				
			CLOGGING INDICATOR**							
			05 = nr. 2 x 1/8" ports, plugged	05	05	05				
			30 = manometer, scale 0 - 600 kPa (0 - 6 bar)	30	30	30				
			P4 = SPDT, pressure switch	P4	P4	P4				
			03 = port for differential indicator, plugged	03	03	03				
			5B = visual differential 130 kPa (1,3 bar)	5B	5B	5B				
			6B = electrical differential 130 kPa (1,3 bar)	6B	6B	6B				
			7B = indicator 6B with LED	7B	7B	7B				
			T0 = elect. diff. 130 kPa (1,3 bar) with thermostat 30°C	T0	T0	T0				
			ACCESSORIES							
			S = without accessory	S	S	S				
			D = with diffusor	D	D	D				
			ACCESSORIES							
			S = without accessory	S	S	S				
			M = magnetic core	M	M	M				

### NOTES

\*\* When the filter is ordered with FKM seals, the first digit of the indicator code is a letter  
(please see Clogging Indicator Chapter for further details)

# FRF

## RETURN FILTERS

### ORDERING AND OPTION CHART

F	R	F	COMPLETE FILTER FAMILY					FILTER ELEMENT FAMILY	E	R	F
			SIZE & LENGTH	31	32	33	34	SIZE & LENGTH			
			PORT TYPE								
			F = SAE flange 3000 psi	F	F	F	F				
			P = SAE flange 3000 psi, double port	P	P	P	P				
			PORT SIZE								
			16 = 2"	16	16	16	16				
			20 = 2" 1/2	20	20	20	20				
			DA = fl. 2" 1/2 + 2"	DA	DA	DA	DA				
			D7 = fl. 2" + 1" 1/2	D7	D7	D7	D7				
		F	BYPASS VALVE								
			F = 170 kPa (1,7 bar)	F	F	F	F				
			SEALS					SEALS			
			N = NBR Nitrile	N	N	N	N				
			F = FKM Fluoroelastomer	F	F	F	F				
			FILTER MEDIA					FILTER MEDIA			
			FA = fibreglass 5 µm(c) β>1.000	FA	FA	FA	FA				
			FB = fibreglass 7 µm(c) β>1.000	FB	FB	FB	FB				
			FC = fibreglass 12 µm(c) β>1.000	FC	FC	FC	FC				
			FD = fibreglass 21 µm(c) β>1.000	FD	FD	FD	FD				
			CC = impregnated cellulose 10 µm β>2	CC	CC	CC	CC				
			ME = wire mesh 60 µm	ME	ME	ME	ME				
			CLOGGING INDICATOR**								
			05 = nr. 2 x 1/8" ports, plugged	05	05	05	05				
			30 = manometer, scale 0 - 600 kPa (0 - 6 bar)	30	30	30	30				
			P4 = SPDT, pressure switch	P4	P4	P4	P4				
			03 = port for differential indicator, plugged	03	03	03	03				
			5B = visual differential 130 kPa (1,3 bar)	5B	5B	5B	5B				
			6B = electrical differential 130 kPa (1,3 bar)	6B	6B	6B	6B				
			7B = indicator 6B with LED	7B	7B	7B	7B				
			T0 = elect. diff. 130 kPa (1,3 bar) with thermostat 30°C	T0	T0	T0	T0				
			ACCESSORIES								
			W = without accessory	W	W	W	W				
			F = with diffusor	F	F	F	F				
			ACCESSORIES								
			W = without accessory	W	W	W	W				
			M = magnetic core	M	M	M	M				

# RFC

## RETURN FILTERS

### ORDERING AND OPTION CHART

R	F	C	COMPLETE FILTER FAMILY					FILTER ELEMENT FAMILY	C	R	C
			SIZE & LENGTH	310	320	330	340	SIZE & LENGTH			
			FILTER MEDIA					FILTER MEDIA			
			FT = fibreglass 5 µm(c) β>1.000	FT	FT	FT	FT				
			FC = fibreglass 7 µm(c) β>1.000	FC	FC	FC	FC				
			FD = fibreglass 12 µm(c) β>1.000	FD	FD	FD	FD				
			FV = fibreglass 21 µm(c) β>1.000	FV	FV	FV	FV				
			CD = impregnated cellulose 10 µm β>2	CD	CD	CD	CD				
			MS = wire mesh 60 µm	MS	MS	MS	MS				
			SEALS					SEALS			
			1 = NBR Nitrile	1	1	1	1				
			2 = FKM Fluoroelastomer	2	2	2	2				
F			BYPASS VALVE								
			F = 170 kPa (1,7 bar)	F	F	F	F				
			PORT TYPE								
			F = SAE flange 3000 psi	F	F	F	F				
			PORT SIZE								
			9 = 2" 1/2	9	9	9	9				
			CLOGGING INDICATOR**								
			05 = nr. 2 x 1/8" ports, plugged	05	05	05	05				
			30 = manometer, scale 0 - 600 kPa (0 - 6 bar)	30	30	30	30				
			P4 = SPDT, pressure switch	P4	P4	P4	P4				
			03 = port for differential indicator, plugged	03	03	03	03				
			5B = visual differential 130 kPa (1,3 bar)	5B	5B	5B	5B				
			6B = electrical differential 130 kPa (1,3 bar)	6B	6B	6B	6B				
			7B = indicator 6B with LED	7B	7B	7B	7B				
			T0 = elect. diff. 130 kPa (1,3 bar) with thermostat 30°C	T0	T0	T0	T0				
			ACCESSORIES								
			S = without accessory	S	S	S	S				
			D = with diffusor	D	D	D	D				
			ACCESSORIES								
			S = without accessory	S	S	S	S				
			M = magnetic core	M	M	M	M				

### NOTES

\*\* When the filter is ordered with FKM seals, the first digit of the indicator code is a letter  
(please see Clogging Indicator Chapter for further details)

# FRF4

## RETURN FILTERS

### ORDERING AND OPTION CHART

F	R	F	COMPLETE FILTER FAMILY						FILTER ELEMENT FAMILY	E	R	F
			SIZE & LENGTH	41	42	43	44		SIZE & LENGTH			
			PORT TYPE									
			F = SAE flange 3000 psi	F	F	F	F					
			P = SAE flange 3000 psi, double port	P	P	P	P					
			PORT SIZE									
			24 = 3"	24	24	24	24					
			32 = 4"	32	32	32	32					
			D9= 3"+ 4"	D9	D9	D9	D9					
		F	BYPASS VALVE									
			F = 170 kPa (1,7 bar)	F	F	F	F					
			SEALS						SEALS			
			N = NBR Nitrile	N	N	N	N					
			F = FKM Fluoroelastomer	F	F	F	F					
			FILTER MEDIA						FILTER MEDIA			
			FA = fibreglass 5 µm(c) β>1.000	FA	FA	FA	FA					
			FB = fibreglass 7 µm(c) β>1.000	FB	FB	FB	FB					
			FC = fibreglass 12 µm(c) β>1.000	FC	FC	FC	FC					
			FD = fibreglass 21 µm(c) β>1.000	FD	FD	FD	FD					
			CC = impregnated cellulose 10 µm β>2	CC	CC	CC	CC					
			ME = wire mesh 60 µm	ME	ME	ME	ME					
			CLOGGING INDICATOR**									
			05 = nr. 2 x 1/8" ports, plugged	05	05	05	05					
			30 = manometer, scale 0 - 600 kPa (0 - 6 bar)	30	30	30	30					
			P4 = SPDT, pressure switch	P4	P4	P4	P4					
			03 = port for differential indicator, plugged	03	03	03	03					
			5B = visual differential 130 kPa (1,3 bar)	5B	5B	5B	5B					
			6B = electrical differential 130 kPa (1,3 bar)	6B	6B	6B	6B					
			7B = indicator 6B with LED	7B	7B	7B	7B					
			T0 = elect. diff. 130 kPa (1,3 bar) with thermostat 30°C	T0	T0	T0	T0					
			ACCESSORIES									
			W = without accessory	W	W	W	W					
			F = with diffuser	F	F	F	F					
			ACCESSORIES									
			W = without accessory	W	W	W	W					
			M = magnetic core	M	M	M	M					

### NOTES

\*\* When the filter is ordered with FKM seals, the first digit of the indicator code is a letter  
(please see Clogging Indicator Chapter for further details)



## SPARE PARTS ELEMENTS

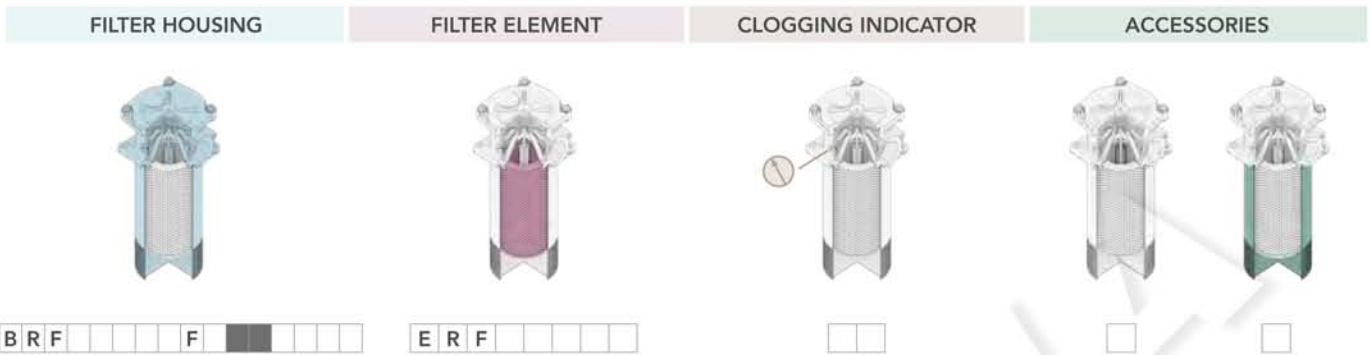

## SPARE SEAL KIT

	NBR	FKM
FRF11 RFC110	521.0055.2	521.0056.2
FRF12 RFC120	521.0055.2	521.0056.2
FRF13 RFC130	521.0055.2	521.0056.2
FRF14 RFC140	521.0055.2	521.0056.2
FRF22 RFC220	521.0020.2	521.0057.2
FRF23 RFC230	521.0020.2	521.0057.2
FRF24 RFC240	521.0020.2	521.0057.2
FRF31 RFC310	521.0021.2	521.0058.2
FRF32 RFC320	521.0021.2	521.0058.2
FRF33 RFC330	521.0021.2	521.0058.2
FRF34 RFC340	521.0021.2	521.0058.2
FRF41	521.0095.2	521.0096.2
FRF42	521.0095.2	521.0096.2
FRF43	521.0095.2	521.0096.2
FRF44	521.0095.2	521.0096.2

## SPARE SPRING

FRF11 RFC110	008.0282.1
FRF12 RFC120	008.0282.1
FRF13 RFC130	008.0282.1
FRF14 RFC140	008.0282.1
FRF22 RFC220	008.0269.1
FRF23 RFC230	008.0269.1
FRF24 RFC240	008.0269.1
FRF31 RFC310	008.0275.1
FRF32 RFC320	008.0275.1
FRF33 RFC330	008.0275.1
FRF34 RFC340	008.0275.1
FRF41	008.0283.1
FRF42	008.0283.1
FRF43	008.0283.1
FRF44	008.0283.1

# FRF1-RFC1

## RETURN FILTERS

### INSTALLATION DRAWING

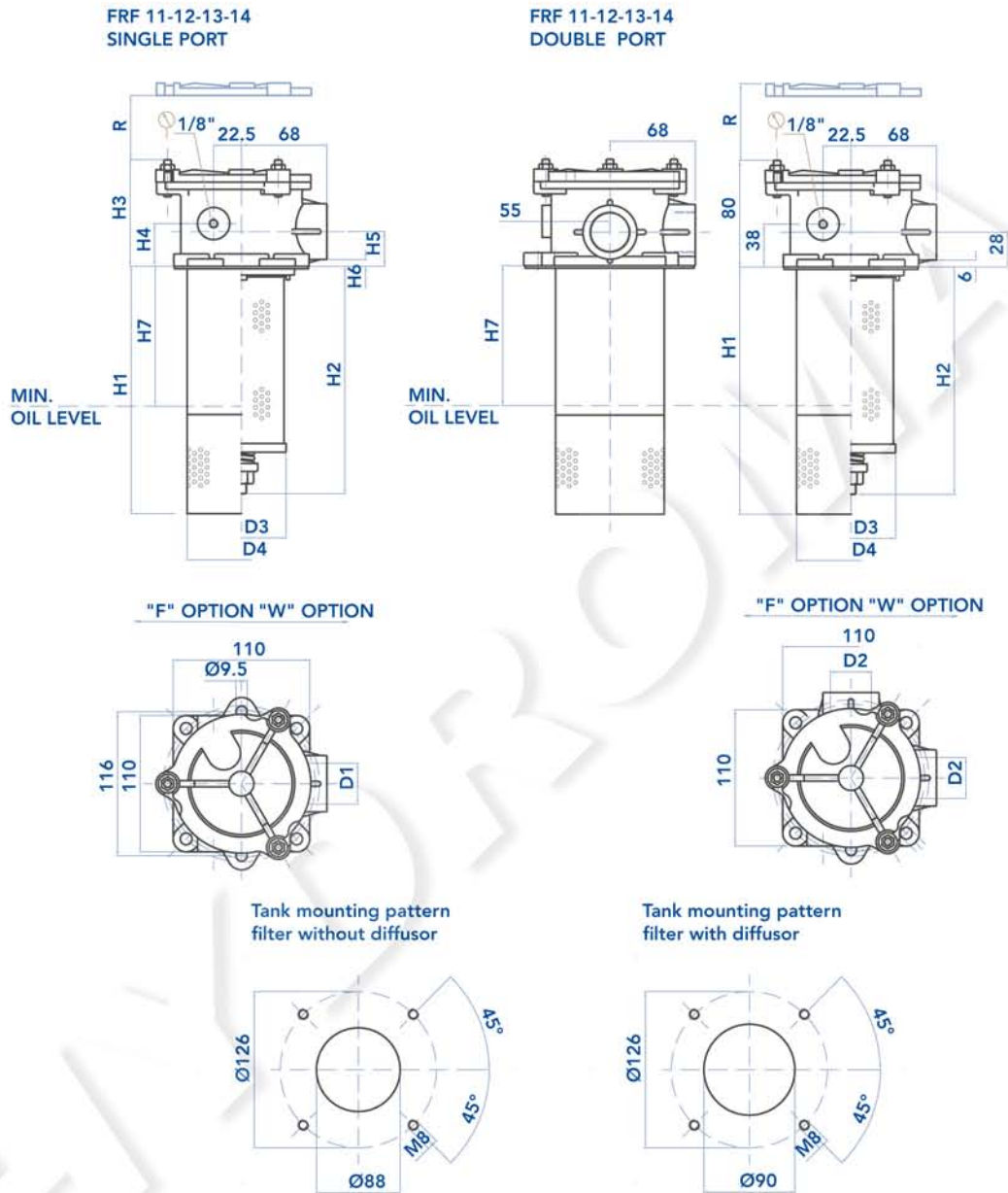

### FILTER HOUSING

	D1	D2	D3	D4	D5	H1	H2	H3	H4	H5	H6	H7	R	Kg
FRF11 RFC110	3/4" - 1" - 1" 1/4	1"	72	89	9	198	140	90	38	28÷32	6	118	230	1,20
FRF12 RFC120	3/4" - 1" - 1" 1/4	1"	72	89	9	198	185	90	38	28÷32	6	118	275	1,40
FRF13 RFC130	3/4" - 1" - 1" 1/4	1"	72	89	9	250	235	90	38	28÷32	6	170	325	1,50
FRF14 RFC140	3/4" - 1" - 1" 1/4	1"	72	89	9	350	335	90	38	28÷32	6	270	445	1,70

# FRF2-RFC2

## RETURN FILTERS

### INSTALLATION DRAWING

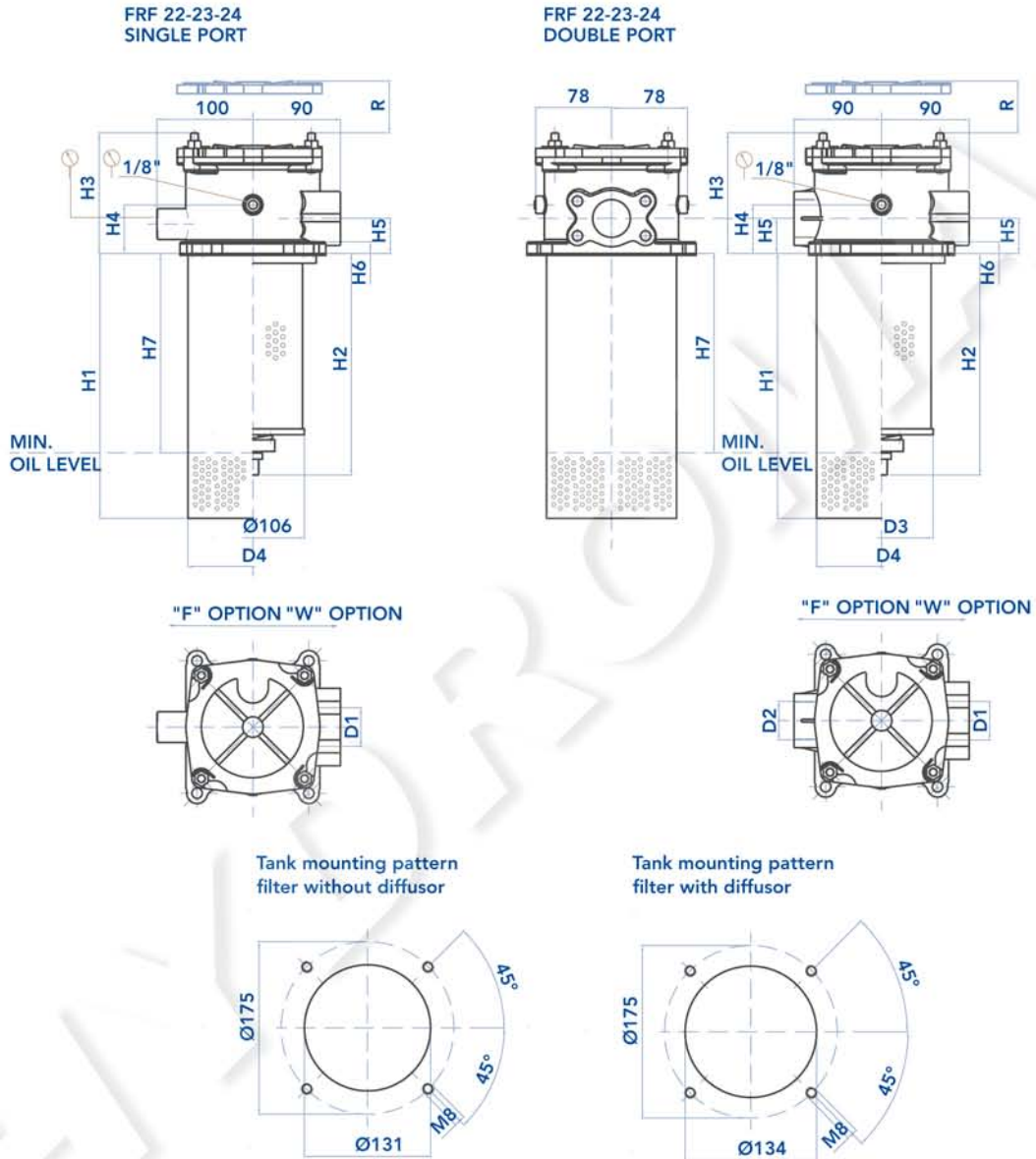

### FILTER HOUSING

	D1	D2	D3	D4	H1	H2	H3	H4	H5	H6	H7	R	Kg
FRF22 RFC220	1" 1/2	1"1/4 ÷ 1"1/2	106	133	250	225	129	50	36	12	150	310	4,20
FRF23 RFC230	1" 1/2	1"1/4 ÷ 1"1/2	106	133	320	295	129	50	36	12	220	380	4,70
FRF24 RFC240	1" 1/2	1"1/4 ÷ 1"1/2	106	133	525	500	129	50	36	12	425	580	5,00

# FRF3-RFC3

## RETURN FILTERS

### INSTALLATION DRAWING

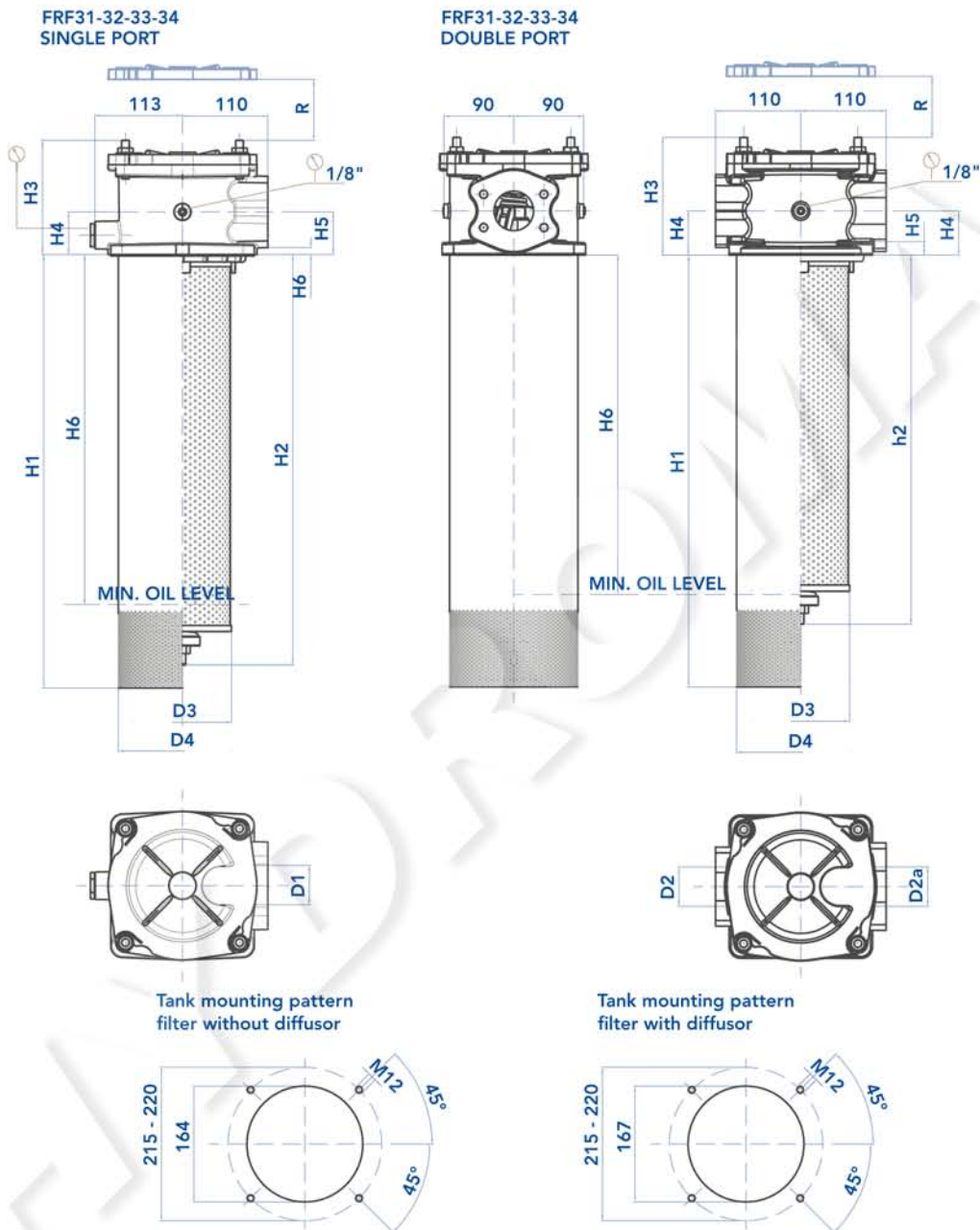

### FILTER HOUSING

	D1	D2	D2a	D3	D4	H1	H2	H3	H4	H5	H6	R	Kg
FRF31 RFC310	2" - 2"1/2	2" - 2"1/2	1"1/2 - 2"	126	165,5	290	260	155	55	14	190	350	8,00
FRF32 RFC320	2" - 2"1/2	2" - 2"1/2	1"1/2 - 2"	126	165,5	370	340	155	55	14	270	430	8,40
FRF33 RFC330	2" - 2"1/2	2" - 2"1/2	1"1/2 - 2"	126	165,5	470	440	155	55	14	370	580	8,60
FRF34 RFC340	2" - 2"1/2	2" - 2"1/2	1"1/2 - 2"	126	165,5	560	530	155	55	14	460	620	9,10

# FRF4

## RETURN FILTERS

### INSTALLATION DRAWING

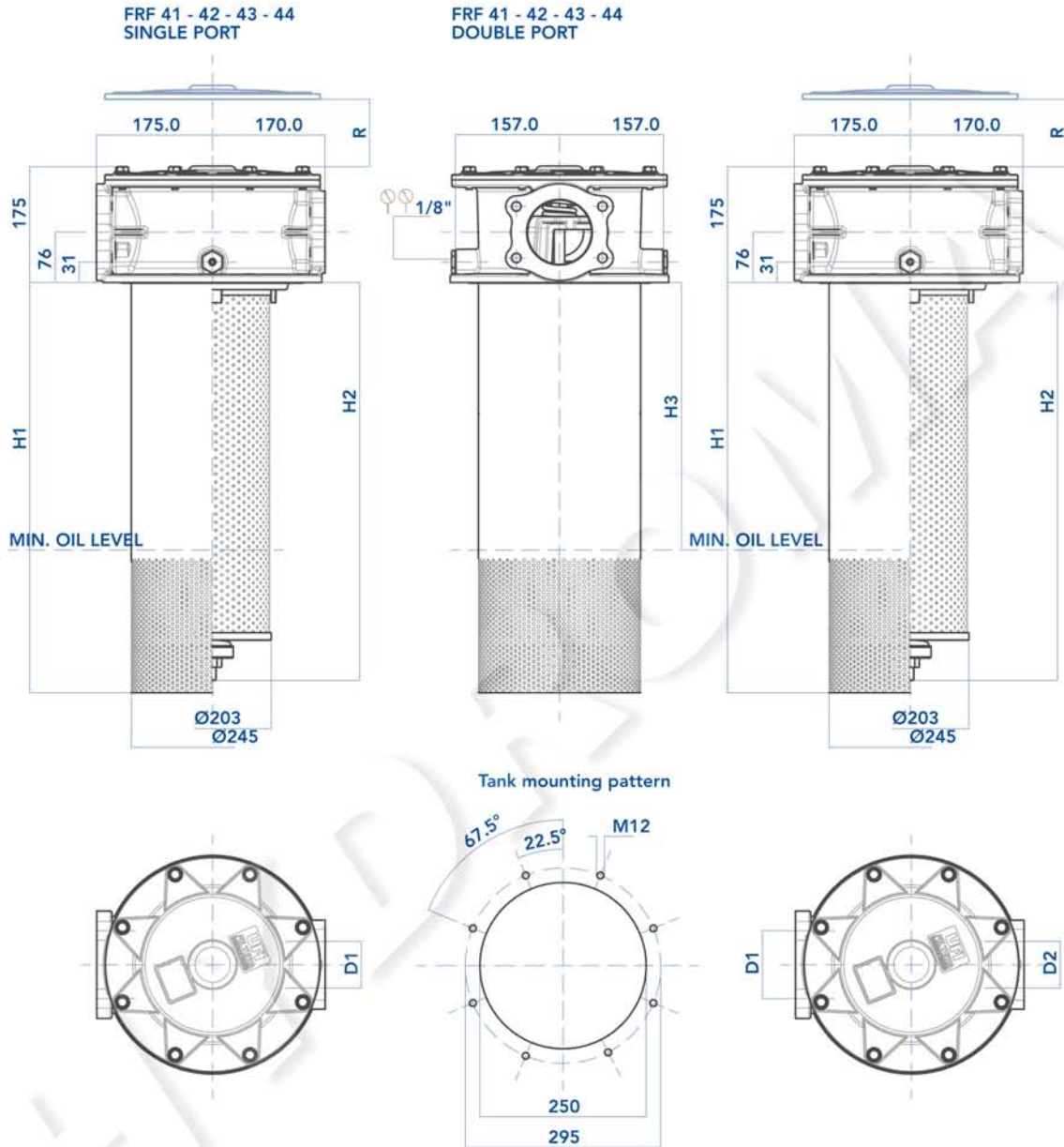

### FILTER HOUSING

	D1	D2	H1	H2	H3	R
FRF41	3"	4"	405	396	205	600
FRF42	3"	4"	620	611	420	810
FRF43	3"	4"	900	891	700	1.090
FRF44	3"	4"	1165	1156	965	1.360

# FRF-RFC

## RETURN FILTERS

### MAINTENANCE

The best time to change your filter element is just before it reaches its maximum dirt-holding capacity. For this reason, we recommend to monitor the pressure of the hydraulic oil flowing through the filter with a clogging indicator. When it is time to change the filter element, switch off the system.

Loosen the nuts of the cover, turn clockwise and remove it. Extract the dirty filter element using the upper handle, if necessary remove the spring.

Unscrew the nut at the bottom of the element from the tie rod. Remove the spring holder and the spring. Replace it with an original UFI element, verifying the part number on the filter label or on the catalogue. Assembly in sequence the spring, the spring holder and screw the nut on the tie rod until it stops. Position the cover and tighten the nuts until it stops.

We recommend the stocking of a spare UFI filter element for timely replacement when required.

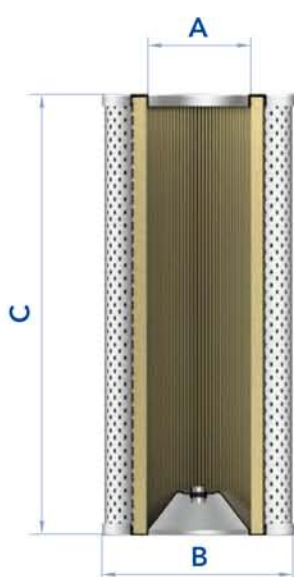

The used filter elements cannot be cleaned and are classified as "Dangerous waste material". They must be disposed according to local laws by authorized Companies. Verify that the Company you choose has the expertise and authorization to dispose this type of waste material.

### FILTER ELEMENT

#### FRF1-RFC1

	A	B	C	Kg	AREA (cm <sup>2</sup> )		
					Media F+	Media C+	Media M+
ERF11 CRC110	45	72	106	0,25	770	1.250	460
ERF12 CRC120	45	72	150	0,35	1.170	1.800	650
ERF13 CRC130	45	72	200	0,45	1.570	2.450	880
ERF14 CRC140	45	72	300	0,60	2.370	3.600	1.320

#### FRF2-RFC2

	A	B	C	Kg	AREA (cm <sup>2</sup> )		
					Media F+	Media C+	Media M+
ERF22 CRC220	72	106	190	0,75	3.900	4.600	1.500
ERF23 CRC230	72	106	260	1,00	5.400	6.400	2.050
ERF24 CRC240	72	106	465	1,50	9.700	11.800	3.670

#### FRF3-RFC3

ERF31 CRC310	92	126	210	1,15	5.500	6.650	2.250
ERF32 CRC320	92	126	290	1,50	7.700	9.200	3.150
ERF33 CRC330	92	126	390	1,90	10.400	12.400	4.250
ERF34 CRC340	92	126	480	2,20	12.800	15.400	5.250

#### FRF4

ERF41	157	203	330	3,90	17.900	22.100	6.400
ERF42	157	203	545	5,20	30.000	37.000	10.800
ERF43	157	203	825	9,00	45.200	55.500	16.200
ERF44	157	203	1.090	13,00	60.000	74.000	21.800

# FRF-RFC

## RETURN FILTERS

### PRESSURE DROP CURVES ( $\Delta P$ ) 1+ DIAGRAMS

The "Assembly Pressure Drop ( $\Delta p$ )" is obtained by adding the pressure drop values of the Filter Housing and of the Clean Filter Element corresponding to the considered Flow

**FILTER HOUSING PRESSURE DROP**  
(mainly depending on the port size)

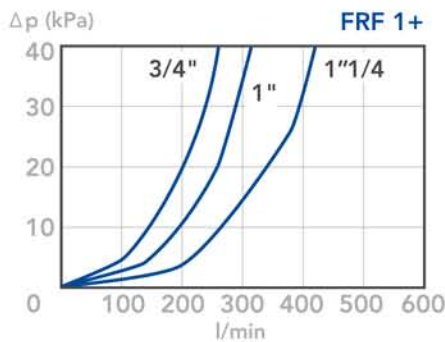

Rate and it must be lower than 50 kPa (0,5 bar) and should never exceed 1/3 of the bypass valve setting.

**BYPASS VALVE PRESSURE DROP**

When selecting the filter size, these curves must be taken into account if it is foreseen that any flow peak is to be absorbed by the bypass valve, it also must be of proper configuration to avoid pressure peaks. The valve pressure drop is directly proportional to fluid specific gravity.

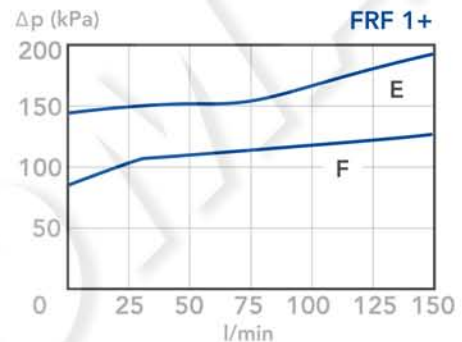

**CLEAN FILTER ELEMENT PRESSURE DROP WITH F+, C AND ME MEDIA**  
(depending both on the internal diameter of the element and on the filter media)

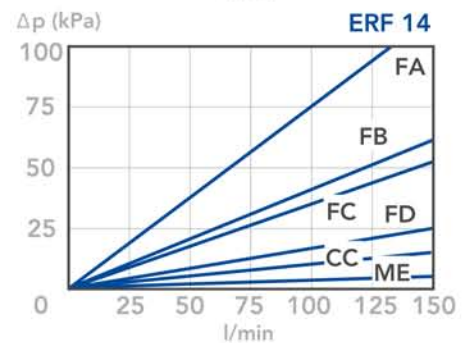
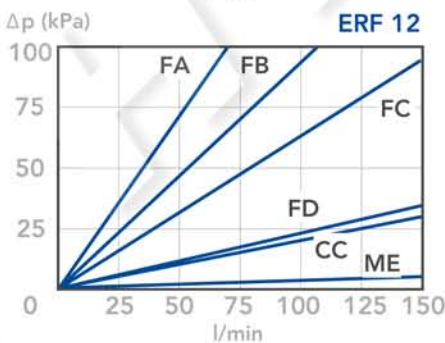
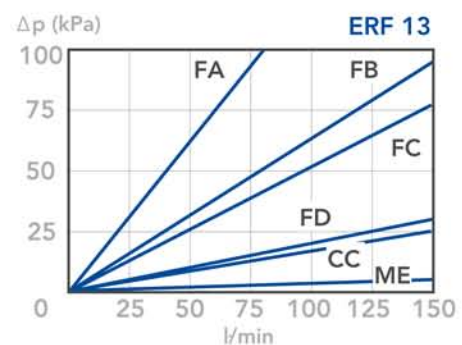
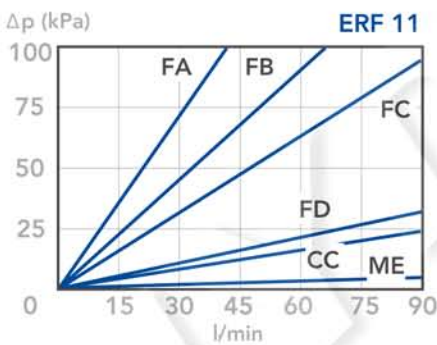

**N.B.**

All the curves have been obtained with mineral oil having a kinematic viscosity 30 cSt and specific gravity 0,86 Kg/dm<sup>3</sup>; for fluids with different features, please consider the factors described in the first part of this catalogue. All the curves

are obtained from test done at the UFI HYDRAULIC DIVISION Laboratory, according to the specification ISO 3968. In case of discrepancy, please check the contamination level, viscosity and features of the fluid in use.

# FRF-RFC

## RETURN FILTERS

### PRESSURE DROP CURVES ( $\Delta P$ ) 2+ DIAGRAMS

The "Assembly Pressure Drop ( $\Delta p$ )" is obtained by adding the pressure drop values of the Filter Housing and of the Clean Filter Element corresponding to the considered Flow

**FILTER HOUSING PRESSURE DROP**  
(mainly depending on the port size)

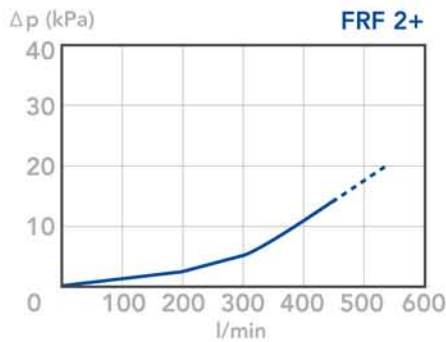

Rate and it must be lower than 50 kPa (0,5 bar) and should never exceed 1/3 of the bypass valve setting.

**BYPASS VALVE PRESSURE DROP**

When selecting the filter size, these curves must be taken into account if it is foreseen that any flow peak is to be absorbed by the bypass valve, it also must be of proper configuration to avoid pressure peaks. The valve pressure drop is directly proportional to fluid specific gravity.

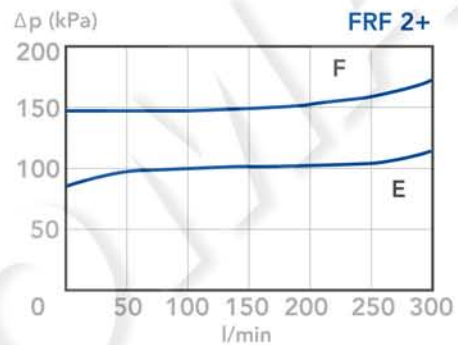

**CLEAN FILTER ELEMENT PRESSURE DROP WITH F+, C+ AND ME MEDIA**  
(depending both on the internal diameter of the element and on the filter media)

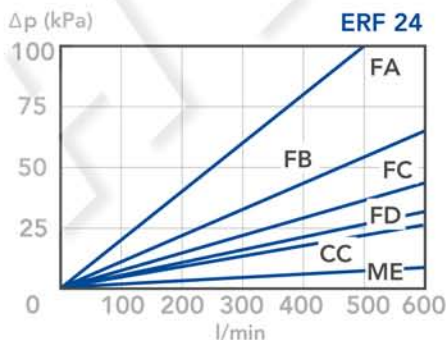
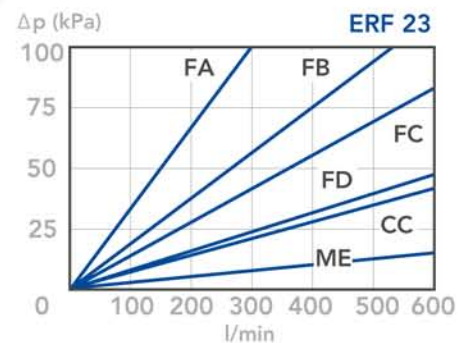
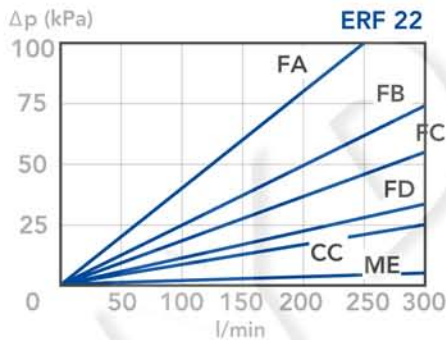

### N.B.

All the curves have been obtained with mineral oil having a kinematic viscosity 30 cSt and specific gravity 0,86 Kg/dm<sup>3</sup>; for fluids with different features, please consider the factors described in the first part of this catalogue. All the curves

are obtained from test done at the UFI HYDRAULIC DIVISION Laboratory, according to the specification ISO 3968. In case of discrepancy, please check the contamination level, viscosity and features of the fluid in use.



# FRF-RFC

## RETURN FILTERS

### PRESSURE DROP CURVES ( $\Delta P$ ) 3+ DIAGRAMS

The "Assembly Pressure Drop ( $\Delta p$ )" is obtained by adding the pressure drop values of the Filter Housing and of the Clean Filter Element corresponding to the considered Flow

**FILTER HOUSING PRESSURE DROP**  
(mainly depending on the port size)

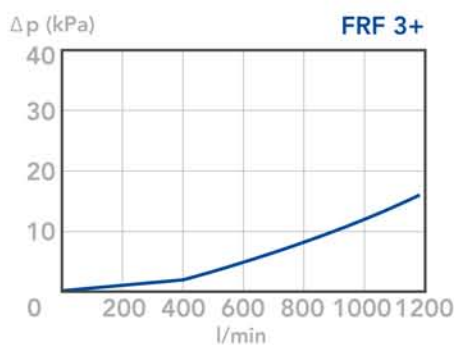

Rate and it must be lower than 50 kPa (0,5 bar) and should never exceed 1/3 of the bypass valve setting.

**BYPASS VALVE PRESSURE DROP**

When selecting the filter size, these curves must be taken into account if it is foreseen that any flow peak is to be absorbed by the bypass valve, it also must be of proper configuration to avoid pressure peaks. The valve pressure drop is directly proportional to fluid specific gravity.

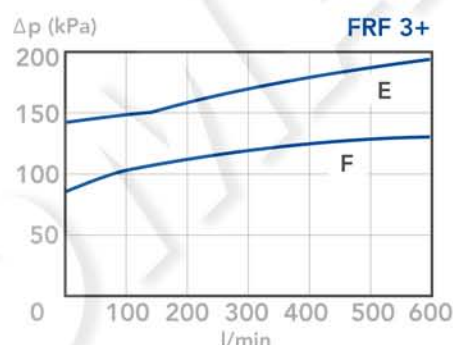

**CLEAN FILTER ELEMENT PRESSURE DROP WITH F+, C+ AND ME MEDIA**  
(depending both on the internal diameter of the element and on the filter media)

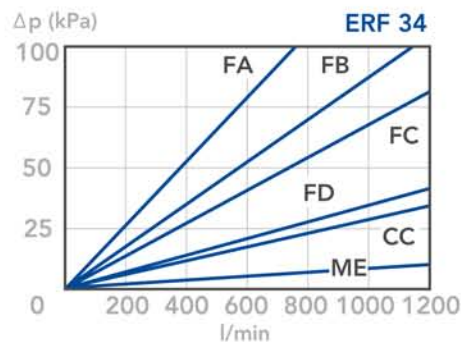
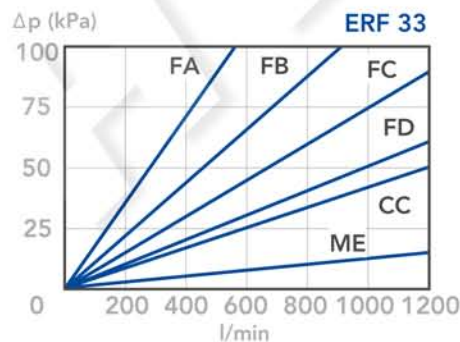
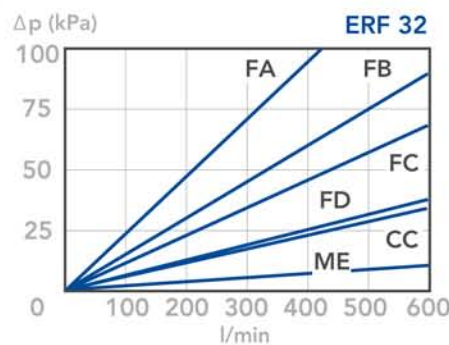
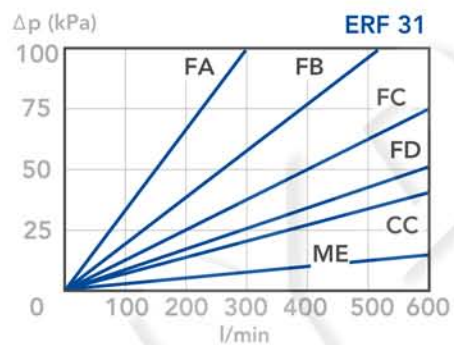

### N.B.

All the curves have been obtained with mineral oil having a kinematic viscosity 30 cSt and specific gravity 0,86 Kg/dm<sup>3</sup>; for fluids with different features, please consider the factors described in the first part of this catalogue. All the curves

are obtained from test done at the UFI HYDRAULIC DIVISION Laboratory, according to the specification ISO 3968. In case of discrepancy, please check the contamination level, viscosity and features of the fluid in use.

# FRF

## RETURN FILTERS

### PRESSURE DROP CURVES ( $\Delta P$ ) 4+ DIAGRAMS

The "Assembly Pressure Drop ( $\Delta p$ )" is obtained by adding the pressure drop values of the Filter Housing and of the Clean Filter Element corresponding to the considered Flow

**FILTER HOUSING PRESSURE DROP**  
(mainly depending on the port size)

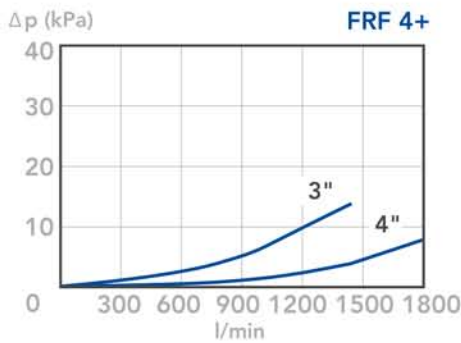

Rate and it must be lower than 50 kPa (0,5 bar) and should never exceed 1/3 of the bypass valve setting.

**BYPASS VALVE PRESSURE DROP**

When selecting the filter size, these curves must be taken into account if it is foreseen that any flow peak is to be absorbed by the bypass valve, it also must be of proper configuration to avoid pressure peaks. The valve pressure drop is directly proportional to fluid specific gravity.

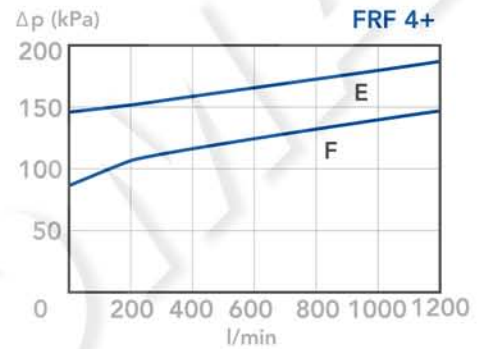

**CLEAN FILTER ELEMENT PRESSURE DROP WITH F+, C+ AND ME MEDIA**  
(depending both on the internal diameter of the element and on the filter media)

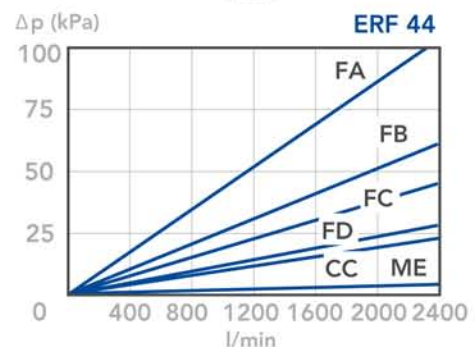
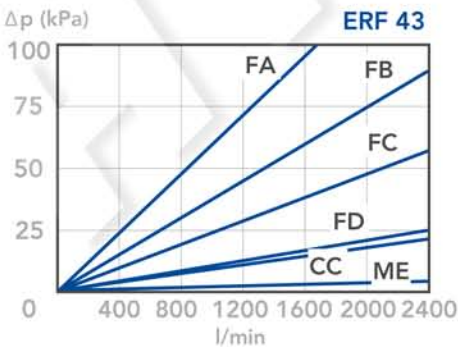
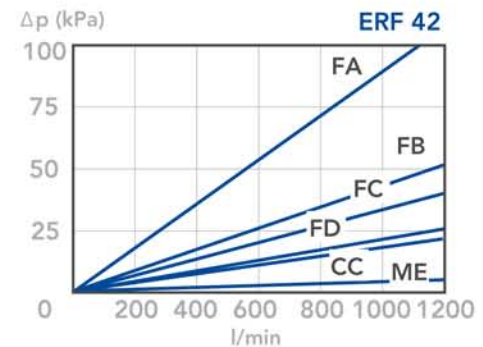
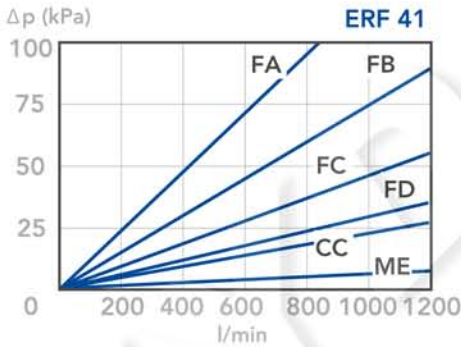

### N.B.

All the curves have been obtained with mineral oil having a kinematic viscosity 30 cSt and specific gravity 0,86 Kg/dm<sup>3</sup>; for fluids with different features, please consider the factors described in the first part of this catalogue. All the curves

are obtained from test done at the UFI HYDRAULIC DIVISION Laboratory, according to the specification ISO 3968. In case of discrepancy, please check the contamination level, viscosity and features of the fluid in use.