

Part number:

HYDROMA

HYDRAULICKÉ SYSTÉMY

**HIDROMA
SISTEMS**

UKŁADY HYDRAULICZNE

HYDROMA

ГИДРАВЛИЧЕСКИЕ СИСТЕМЫ



ELIKA[®]
by **MARZOCCHI**

*The new Marzocchi
Low – noise and
Low – ripple
gear pump*



ELIKA, Marzocchi's new proposal for the gear pumps market, is a perfect fit for all those applications that require low noise levels. The use of ELIKA gear pump eliminates adverse noise effects on humans and on the surrounding environment. The ELIKA reduces the noise level by an average of 15 dBA compared with a conventional external gear pump. ELIKA is a patented product.

ELI2 is the first series ELIKA's family and includes pumps with displacement from 7 to 35 cm³/rev; perfectly interchangeable with the standard gear pumps ALP2 and GHP2 series. The maximum operating pressures are similar to those of GHP2 series and extend up to 300 bar. The helical gear ensures the continuity of the motion despite the low number of teeth. The low number of teeth reduces the fundamental frequencies of the pump noise, producing a more pleasant sound. The particular shape of the profile without encapsulation significantly reduces pressure-oscillations and vibrations produced by the pump and transmitted to the other components, reducing the noise of the hydraulic system. Axial forces induced by the helical teeth are optimally balanced in all operating conditions by the axial compensation system integrated in the pump cover. Specific compensation areas into flange and cover, insulated by special gaskets reinforced with anti extrusion, allow for fully free axial and radial movement of the bushings, which is proportional to pump operating pressure. In this way, internal leakage is dramatically reduced, ensuring very good volumetric and mechanical pump performances, as well as proper lubrication of pump's moving parts. ELIKA pumps are available in both unidirectional clockwise or counter clockwise rotation.

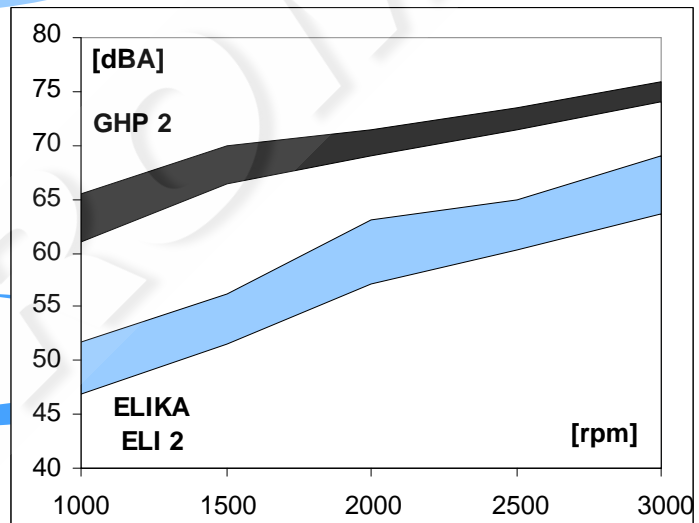

Noise pump comparison [dBA] Marzocchi GHP2 – ELIKA ELI 2, same displacement 17.8 cm³/rev.

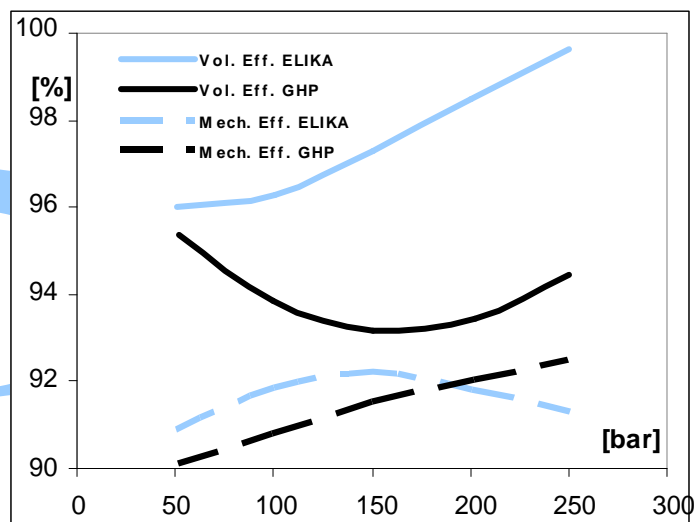

Efficiency pump comparison [%] Marzocchi GHP2 – ELIKA ELI 2, same displacement 17.8 cm³/rev.

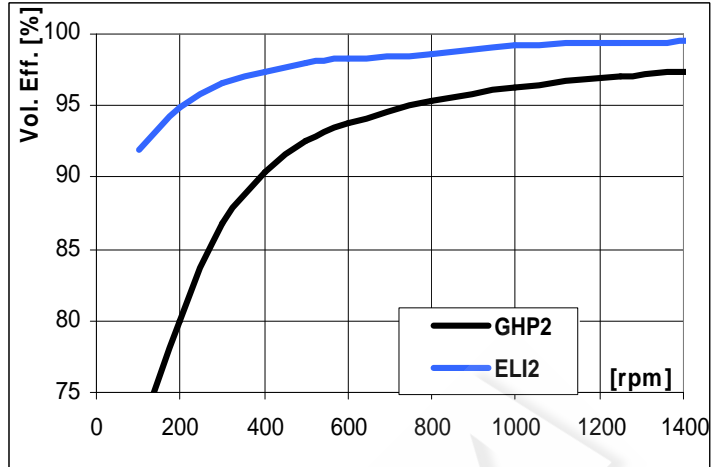
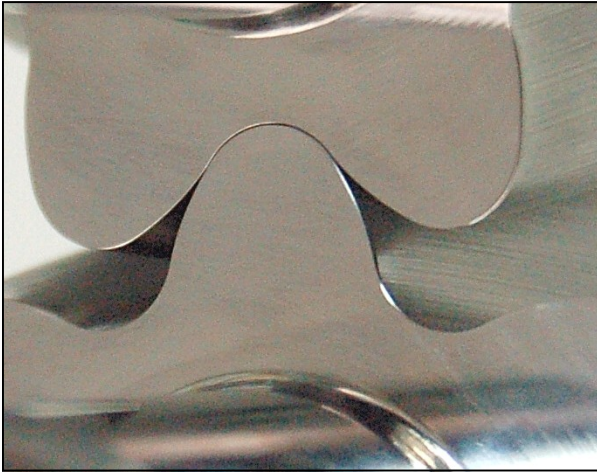

Comparison of volumetric efficiency at low rotation speed: Marzocchi GHP 2 – ELIKA ELI 2, displacement 17.8 cm³/rev; P = 200 bar.

The particular shape of the Erika profile patented by Marzocchi Pompe, eliminates the phenomenon of encapsulation typical of normal gear pumps, deleting the source of the main cause of noise and vibrations. The structure of the pump minimizes the internal leakage, maximizing the volumetric efficiency under all conditions. This feature makes the Erika pump suitable for work operations with low speed and high pressure. The internal leakage, virtually eliminated in the Erika pumps, laminating to outlet from the inlet, overheat the pump components. Comparing the characteristics of the pumps Erika with other kind of volumetric pumps, on can see that they have a very high field of use like: the rotation speed, work pressure and viscosity range.

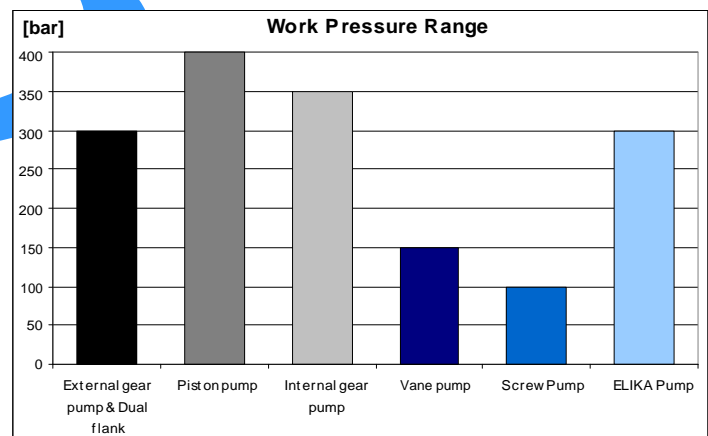
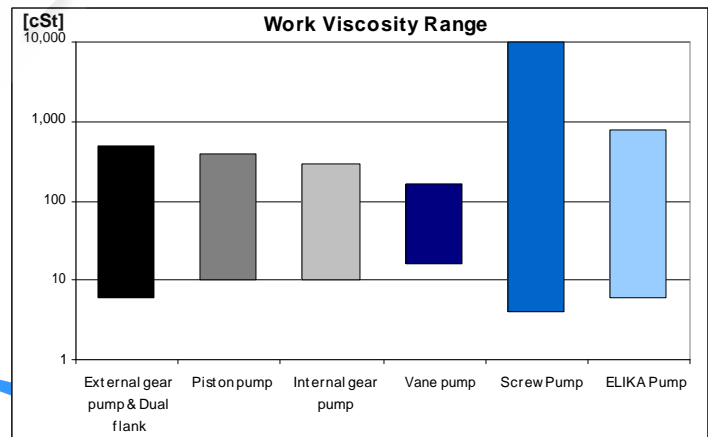
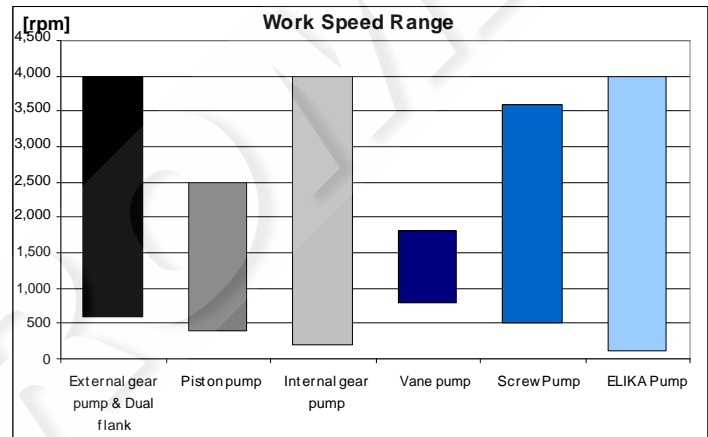

On side: comparison between the different fields of use of different kinds of volumetric pumps.

- External gear pump & Dual flank
- Piston pump
- Internal gear pump
- Vane pump
- Screw Pump
- ELIKA Pump

The very low noise level generated by the ELIKA pumps makes this product particularly suitable for those applications where screw pumps, vane pumps or internal gear pumps are generally used. The simple construction, small size and high performances of ELIKA make this new product very competitive.

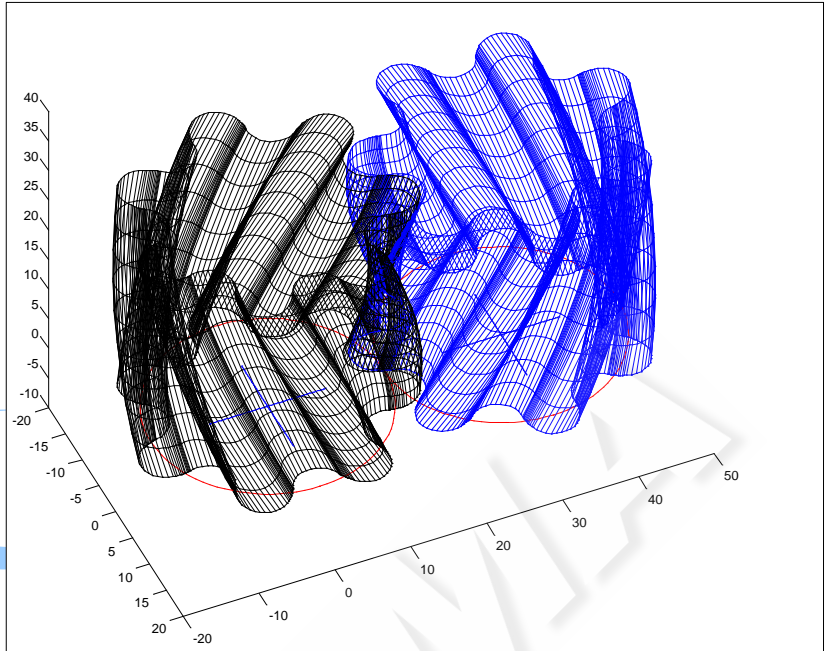

Noise comparison between:
 standard external gear pump,
 dual flank gear pump,
 internal gear pump,
 vane pump,
 ELIKA pump.

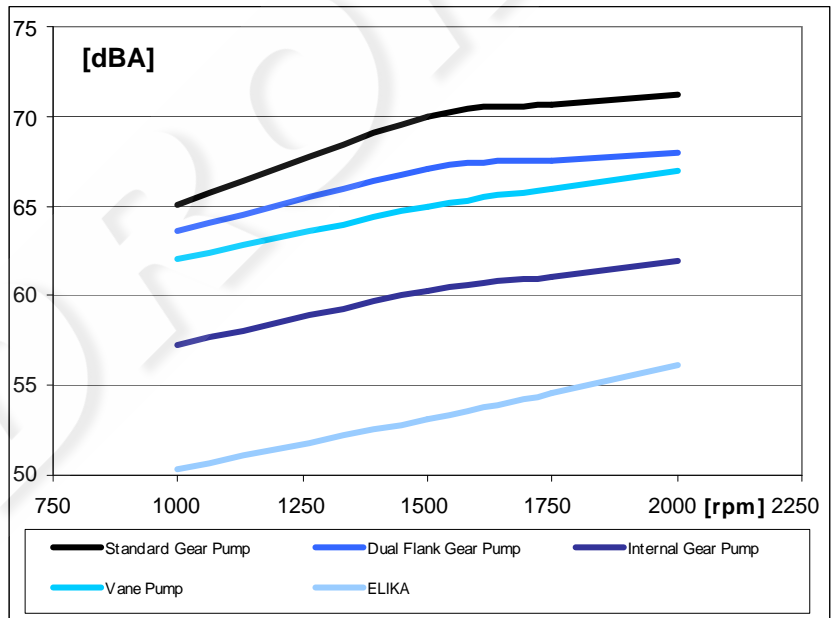

The low pulsation reduces the induced vibration in the machines. The lower frequency of ELIKA pump produces a more pleasant sound. Pressure pulsation comparison between:
 standard external gear pump,
 dual flank gear pump,
 ELIKA pump.

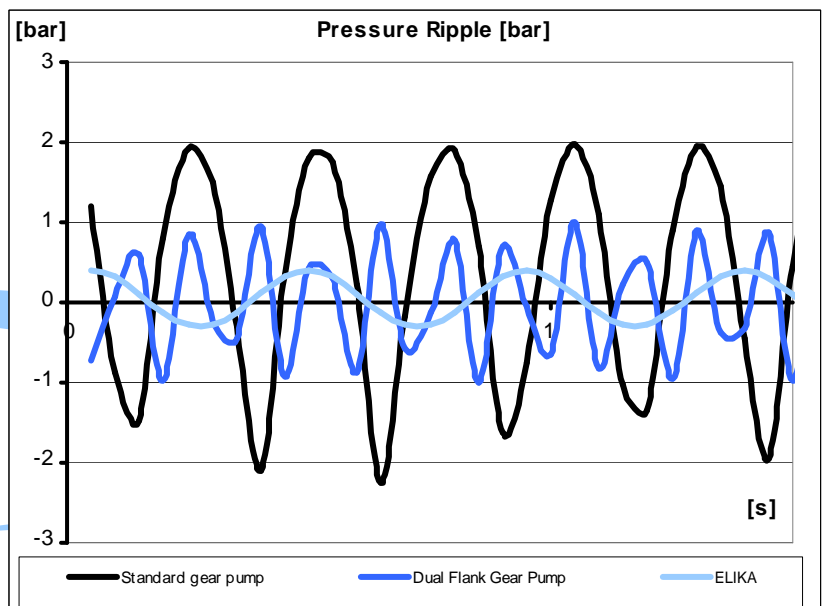

INSTALLATION NOTES

Please strictly follow assembly and use indications given in this catalogue for top performance, longer life and noise of the ELI Marzocchi series. Some general considerations should be made on the hydraulic system, in which the pump must be fitted. Special attention shall be devoted to hydraulic system design and assembly, especially to intake, delivery and return pipes and position of system parts (valves, filters, tanks, heat exchangers and accumulators). Proper safety devices and reliable instruments to avoid fluid turbulence, especially in return pipe to the tank, and prevent air, water and foreign bodies from entering into the system are of mayor importance. It is also very important to equip the hydraulic system with a proper filtering unit. Before starting the system on a continuous basis, we suggest to adopt some simple precautions: – Check for the direction of rotation of the pump to be consistent with the drive shaft one. – Check for the proper alignment of pump shaft and motor shaft: it is necessary that the connection does not induce axial or radial loads. – Protect drive shaft seal during pump painting. Check if contact area between seal ring and shaft is clean: dust could provoke quicker wear and leakage. – Remove all dirt, chips and all foreign bodies from flanges connecting inlet and delivery ports. – Ensure that intake and return pipes are always below fluid level and as far from each other as possible. – Install the pump below head, if possible. – Fill the pump with fluid, and turn it by hand. – At first startup, set pressure limiting valves at min. value possible. – Avoid lower rotation speed than min. allowed with pressure higher than P1. – Do not start the system at low temperatures under load conditions or after long stops (always avoid or limit load starting for pump longer life. Start the system for a few minutes and turn on all components; bleed air off the circuit its proper filling.– Check fluid level in the thank after loading all components.– At least, gradually increase pressure, continuously check fluid and moving parts temperature, check rotation speed until you reach set operating values that shall be within the limits indicated in this catalogue.

CLEANING AND FILTERING THE SYSTEM

It is widely known that most pumps early failures are due to contaminated fluids. The extreme reduction of the tolerances required in the design of the pumps and therefore their operation with minimum clearances, are heavily influenced by a fluid that is not perfectly clean. It is proved that particles circulating in the fluid act as abrasive agents, damaging the surfaces they touch and increasing the quantity of contaminant. For this reason, ensure that system is perfectly clean during startup and keep it clean for this whole operating life. Necessary interventions to check and limit contamination should be performed in a preventive and corrective way. Preventive actions include: proper cleaning of the system during assembly, deburring, eliminating the welding scum and fluid filtering before filling up. Starting contamination level of system fluid should not exceed class 18/15 (ref. ISO 4406). Even fresh fluids might exceed this contamination level; therefore always pre-filter the fluid when filling up or topping up the system. Fit a proper tank; its capacity should be proportional to the volume displaced by the pump in one working minute. Fluid contamination level check and correction during operation can be obtained through filters that retain the particles in the fluid. Two parameters tell which filter is most suitable: absolute filtering power and β filtering ratio. Low absolute filtering power and high β filtering ratio for small particles help ensuring good filtration. It is then very important to limit not only max dimensions, but also the number of smaller particles that pass through the filter. It goes without saying that with an operating pressure increase and according to the system sophistication degree, filtering should become more and more efficient. The filtering system shall always ensure contamination levels not exceeding the values indicates below.

Pressione	Pressure	< 140 bar	140 ÷ 210 bar	> 210 bar
Classe NAS 1638	NAS 1638 Class	10	9	8
Classe ISO 4406	ISO 4406 Class	19/16	18/15	17/14
Rapporto $\beta_x = 75$	Ratio $\beta_x = 75$	25 – 40 μm	12 – 15 μm	6 – 12 μm

HYDRAULIC FLUIDS

Use specific mineral oil based hydraulic fluids having good anti-wear, anti-foaming (rapid de-aeration), antioxidant, anti-corrosion and lubricating proprieties. Fluids should also comply with DIN 51525 and VDMA 24317 standards and get through 11 stage of FZG test. For the standard models, the temperature of the fluid should be between -10°C and $+80^{\circ}\text{C}$. Fluid kinematic viscosity ranges are the following:

Permessi (previa verifica)	Allowed value (upon verification)	6 ÷ 500 cSt
Raccomandati	Recommended value	10 ÷ 100 cSt
Consentiti all'avviamento	Value allowed at startup	< 2000 cSt

If fluids other than the above mentioned ones are used, please always indicate type of used fluid and operating conditions so that our Sales and Technical Dept. can weigh possible problems on compatibility or useful life of system parts.

INLET PRESSURE

Under standard working conditions, intake pipe pressure is lower than atmospheric pressure. The operating inlet pressure should range between 0.7 and 3 bars (absolute).

INLET AND DELIVERY LINES

Hydraulic system pipes should show no sudden changes of direction, sharp bends and sudden differences in cross-section. They should not be too long or out of proportion. Pipe cross-section should be sized so that fluid velocity does not exceed recommended values. It is advisable to carefully consider the possible diameter reduction of the inlet or outlet pipes fitted on flange fittings. Reference values are the following:

Condotto di aspirazione	Intake line	0.5 ÷ 1.6 m/s
Condotto di mandata	Delivery line	2.0 ÷ 6.0 m/s
Condotto di ritorno	Return line	1.6 ÷ 3.0 m/s

PRESSURE DEFINITION

Product tables show three max pressure levels [P1, P2, P3] to which each pump can be used.

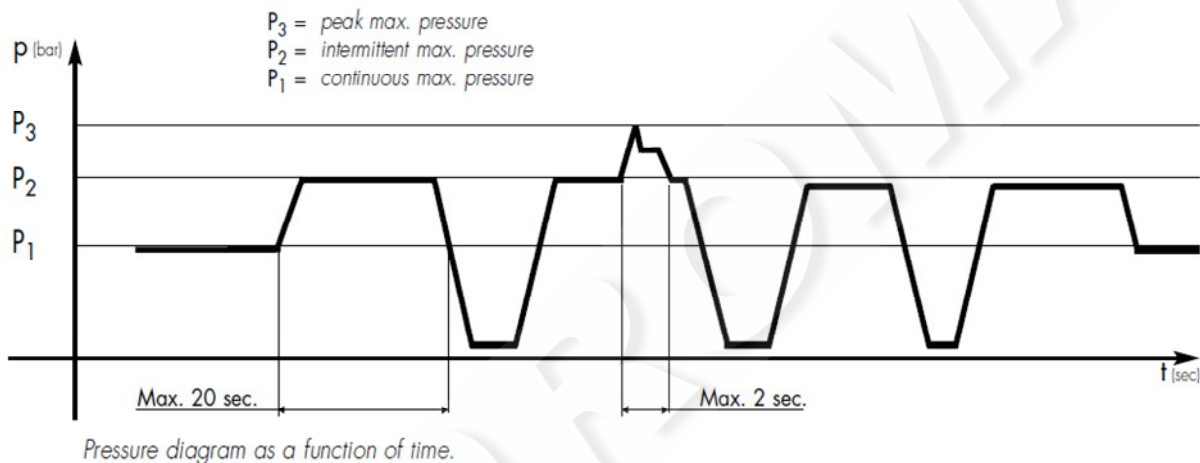

DIRECTION OF ROTATION

Marzocchi ELI series pumps are available in both single rotation. Direction of rotation of single rotation pumps is conventionally defined as follows: when standing before the pump with driving shaft up with its projecting end towards the observer, the pump is rotating clockwise in case of right-hand rotation "D"; therefore, delivery side is on the right, whereas intake side is on the left: The contrary will happen with left-handed pumps "S", keeping the same point of view. The ELI pumps can not be modified in order to reverse the work rotation direction.

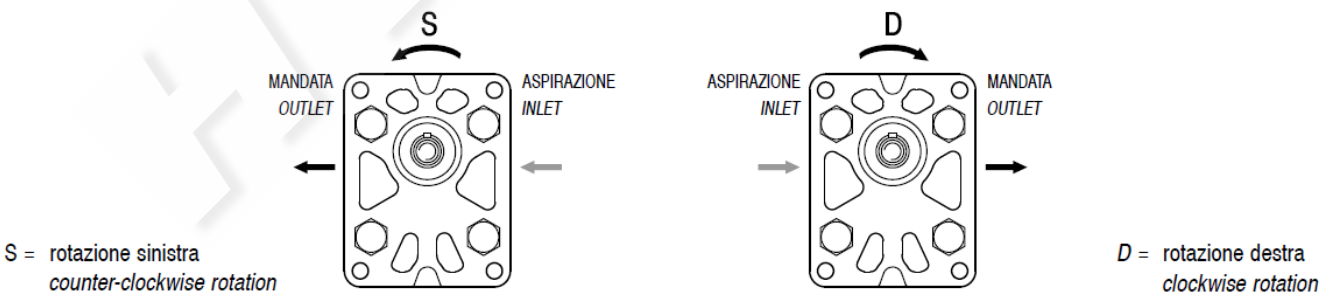

DRIVE

Connect the pump to the motor using either a flexible coupling (either box or Oldham coupling) so that no radial and/or axial force is transmitted to the pump shaft during rotation, otherwise pump efficiency will dramatically drop due to early wear of inner moving parts. Therefore, coupling must absorb inevitable—even though reduced—misalignment between pump shaft and motor shaft. Box coupling or Oldham coupling should also move axially freely enough (enough for proper contact surface onto pump driving shaft). Furthermore, to avoid early wear of either splined or Oldham couplings, they should be lubricated at regular intervals using specific grease. Please contact our Sales or Technical Depts. For further details.

SEALS

“N” Standard version on NBR the temperature of the fluid should be between -10°C and $+80^{\circ}\text{C}$.

“V” Fluorocarbon version suitable for fluid at high temperatures. Range between -10°C and $+120^{\circ}\text{C}$. In the range between -10°C and $+80^{\circ}\text{C}$ pressures P1, P2 e P3 are possible as per product table; beside that P1 should not be exceeded.

FREQUENTLY USED FORMULAS

Fluid velocity

Calculate the velocity [v] of a fluid in a pipe as follows:

$$v = Q / 6 \times A \quad [\text{m/s}]$$

Q = flow rate [liter/min]

A = inside area of pipe [cm^2]

Delivered flow rate

Calculate flow rate [Q] as follows:

$$Q = V \times n \times \eta_{\text{vol}} \times 10^{-3} \quad [\text{liter/min}]$$

V = displacement [$\text{cm}^3/\text{rotation}$]

n = rotation speed [rpm]

η_{vol} = pump volumetric efficiency (take 0.97 as an indicative value for rotation speeds ranging between 1000 and 2000 rpm)

Absorbed torque

Calculate necessary torque [M] of a pump subject to a pressure differential between inlet and delivery as follows:

$$M = (V \times \Delta P) / (62.8 \times \eta_{\text{hm}}) \quad [\text{Nm}]$$

V = displacement [$\text{cm}^3/\text{rotation}$]

ΔP = pressure differential [bar]

η_{hm} = hydromechanical efficiency (take 0.80 as indicative value under cold conditions and 0.85 under working conditions)

Absorbed power

Calculate hydraulic power [P] transferred to fluid from a pump subject to pressure differential between inlet and delivery as follows:

$$P = (Q \times \Delta P) / (600 \times \eta_{\text{tot}}) \quad [\text{kW}]$$

Q = flow rate [liter/min]

ΔP = pressure differential [bar]

η_{tot} = total pump efficiency ($\eta_{\text{hm}} \times \eta_{\text{vol}}$)

Values for η_{vol} and η_{hm} (and consequently η_{tot}) depend on pressure differential between inlet and delivery, rotation speed, fluid features (temperature and viscosity) and filtering degree. Call our Sales and Technical Dept. for further details on efficiency. The proper values for flow rate, torque and power absorbed according to pressure differential, rotation speed and set test conditions, can be found on the pages dedicated to the performance curves.

Flow ELI2 pumps

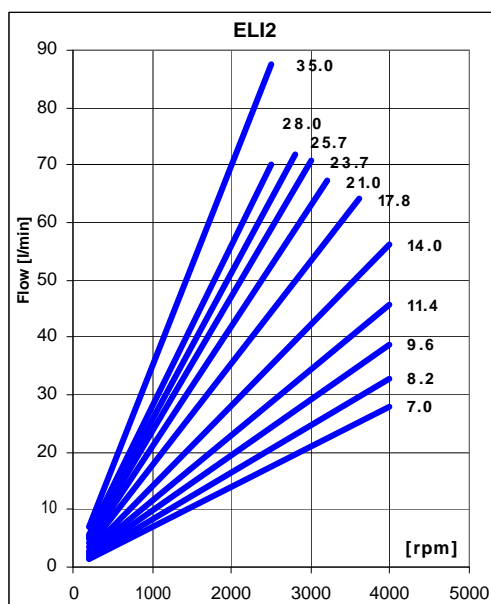

How to order

ELI	TYPE	ROTATION	DISPL.	SHAFT	PORTS	SEALS
	2	D - CW	7.0	T0	D	N
	2A	S - CCW	8.2	T1	FA	V
	2BK1		9.6	T2		
	2BK2		11.4	C1		
	2BK4		14.0	S1		
	2BK7		16.1	S3		
			17.8	S4		
			21.0	G0		
			23.7			
			25.7			
			28.0			
			35.0			

Pump standard types:

2	= european flange + shaft T0 + ports D + standard seals
2A	= flange A + shaft C1 + ports FA + standard seals
2BK1	= flange BK1 + shaft T1 + ports D + standard seals
2BK2	= flange BK2 + shaft T1 + ports D + standard seals
2BK4	= flange BK4 + shaft T1 + ports D + standard seals
2BK7	= flange BK7 + shaft G0 + port D + standard seals

Examples:

ELI2-D-8.2-T0-D-N	= clockwise rotation, 8.2 cm ³ /rev, european flange, 1:8 tapered shaft, flanged ports D type, standard seals.
ELI2-D-8.2-S1-D-N	= clockwise rotation, 8.2 cm ³ /rev, european flange, splined shaft S1, flanged ports D type, standard seals.
ELI2A-D-8.2-S1-FA-N	= clockwise rotation, 8.2 cm ³ /rev, SAE flange, splined shaft S3, threaded ports FA, standard seals.
ELI2BK1-S-8.2-T1-D-N	= counterclockwise rotation, 8.2 cm ³ /rev, BK1 flange, 1:5 tapered shaft, flanged ports D type, standard seals.
ELI2BK7-D-8.2-G0-D-V	= clockwise rotation, 8.2 cm ³ /rev, BK7 flange, shaft G0, flanged ports D type, fluorocarbon seals.

The product data sheets show our standard model types. The synoptic tables for flanges, shafts and ports show all the possible configurations. For further details about the availability of each configuration please contact our Sales and Technical Dept.

* Value based on ISO4412 test procedure

ELI2

Outlet

Inlet

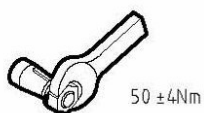
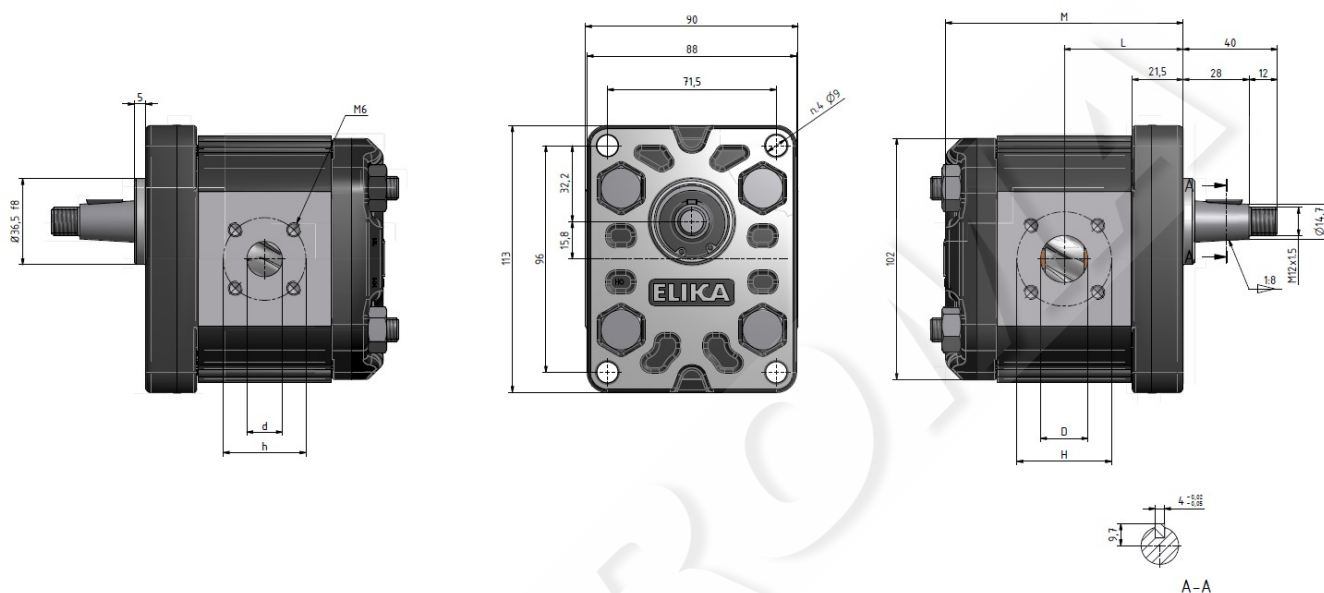

Pump Type	Displacement	Flow at 1500 rpm	Operating pressures			Rotation speed		Noise at 1500 rpm *		Dimensions					
			P1 Max cont.	P2 Max intermittent	P3 Max peak	Minimum speed	Maximum speed	On recirculation	at P1	L	M	D	H	d	H
	[cm ³ /rev]	[l/min]	[bar]	[bar]	[bar]	[rpm]	[rpm]	[dBA]	[dBA]	[mm]	[mm]	[mm]	[mm]	[mm]	[mm]
ELI2-D-7.0	7.0	10.5	280	295	310	500	4000	47	51	48.0	96.0	15	40	15	35
ELI2-D-8.2	8.2	12.3	280	295	310	500	4000	47	52	49.0	98.0	15	40	15	35
ELI2-D-9.6	9.6	14.5	280	295	310	500	4000	48	54	50.3	100.5	20	40	15	35
ELI2-D-11.4	11.4	17.1	280	295	310	500	4000	48	55	51.8	103.5	20	40	15	35
ELI2-D-14.0	14.0	21.0	260	275	290	500	4000	49	55	54.0	108.0	20	40	15	35
ELI2-D-16.1	16.1	24.1	260	275	290	500	4000	49	56	55.8	111.5	20	40	15	35
ELI2-D-17.8	17.8	26.7	260	275	290	500	4000	49	57	57.3	114.5	20	40	15	35
ELI2-D-21.0	21.0	31.5	230	245	260	300	3500	49	57	60.0	120.0	20	40	15	35
ELI2-D-23.7	23.7	35.5	230	245	260	300	3200	50	57	62.3	124.5	20	40	15	35
ELI2-D-25.7	25.7	38.6	210	225	240	300	3000	50	57	64.0	128.0	20	40	15	35
ELI2-D-28.0	28.0	42.1	200	215	230	300	2600	50	58	66.0	132.0	20	40	15	35
ELI2-D-35.0	35.1	52.6	150	165	180	300	2200	50	58	72.0	144.0	20	40	15	35

Accessories supplied with the standard pump: woodruff key (code 522057), M12x1.5 hexagonal nut (code 523016), washer (code 523005). Standard ports: M6 threads depth 13 mm. Please strictly follow assembly and use indications given in this catalogue for top performance and longer life of the ELI Marzocchi series. It is also very important to equip the hydraulic system with a proper filtering unit.

ELI2A

Outlet

Inlet

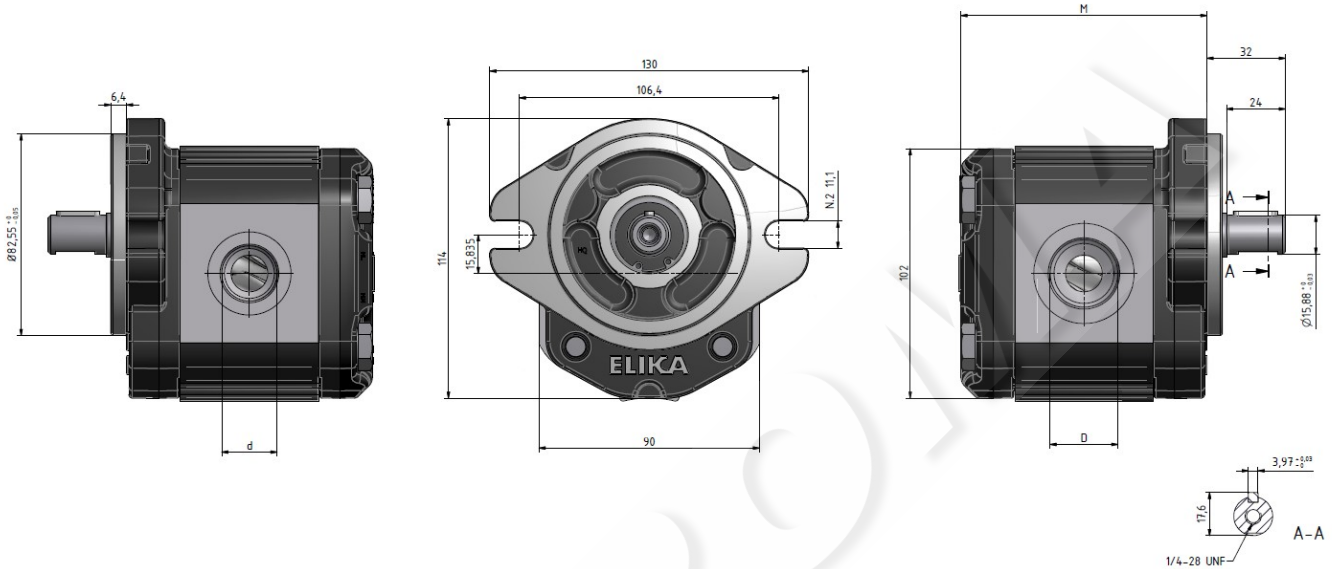

Pump Type	Displacement at 1500 rpm	Flow at 1500 rpm	Operating pressures			Rotation speed		Noise at 1500 rpm *		Dimensions			
			P1 Max cont.	P2 Max intermittent	P3 Max peak	Minimum speed	Maximum speed	On recirculation	at P1	L	M	D	d
	[cm ³ /rev]	[l/min]	[bar]	[bar]	[bar]	[rpm]	[rpm]	[dBA]	[dBA]	[mm]	[mm]	[mm]	[mm]
ELI2A-D-7.0	7.0	10.5	280	295	310	500	4000	47	51	48.0	96.0	1 1/16-12 UNF	7/8-14 UNF
ELI2A-D-8.2	8.2	12.3	280	295	310	500	4000	47	52	49.0	98.0	1 1/16-12 UNF	7/8-14 UNF
ELI2A-D-9.6	9.6	14.5	280	295	310	500	4000	48	54	50.3	100.5	1 1/16-12 UNF	7/8-14 UNF
ELI2A-D-11.4	11.4	17.1	280	295	310	500	4000	48	55	51.8	103.5	1 1/16-12 UNF	7/8-14 UNF
ELI2A-D-14.0	14.0	21.0	260	275	290	500	4000	49	55	54.0	108.0	1 1/16-12 UNF	7/8-14 UNF
ELI2A-D-16.1	16.1	24.1	260	275	290	500	4000	49	56	55.8	111.5	1 1/16-12 UNF	7/8-14 UNF
ELI2A-D-17.8	17.8	26.7	260	275	290	500	4000	49	57	57.3	114.5	1 1/16-12 UNF	7/8-14 UNF
ELI2A-D-21.0	21.0	31.5	230	245	260	300	3500	49	57	60.0	120.0	1 1/16-12 UNF	7/8-14 UNF
ELI2A-D-23.7	23.7	35.5	230	245	260	300	3200	50	57	62.3	124.5	1 1/16-12 UNF	7/8-14 UNF
ELI2A-D-25.7	25.7	38.6	210	225	240	300	3000	50	57	64.0	128.0	1 1/16-12 UNF	7/8-14 UNF
ELI2A-D-28.0	28.0	42.1	200	215	230	300	2600	50	58	66.0	132.0	1 1/16-12 UNF	7/8-14 UNF
ELI2A-D-35.0	35.1	52.6	150	165	180	300	2200	50	58	72.0	144.0	1 5/16-12 UNF	7/8-14 UNF

Accessories supplied with the standard pump: key (code 522067). Mounting flange 82-2 (A) in compliance with SAE J744C. "D" and "d" ports are machined in compliance with threaded port with O-ring seal in truncated housing SAE J1926/1 (ISO 11926-1). Please strictly follow assembly and use indications given in this catalogue for top performance and longer life of the ELI Marzocchi series. It is also very important to equip the hydraulic system with a proper filtering unit.

ELI2BK1

Outlet

Inlet

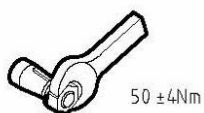
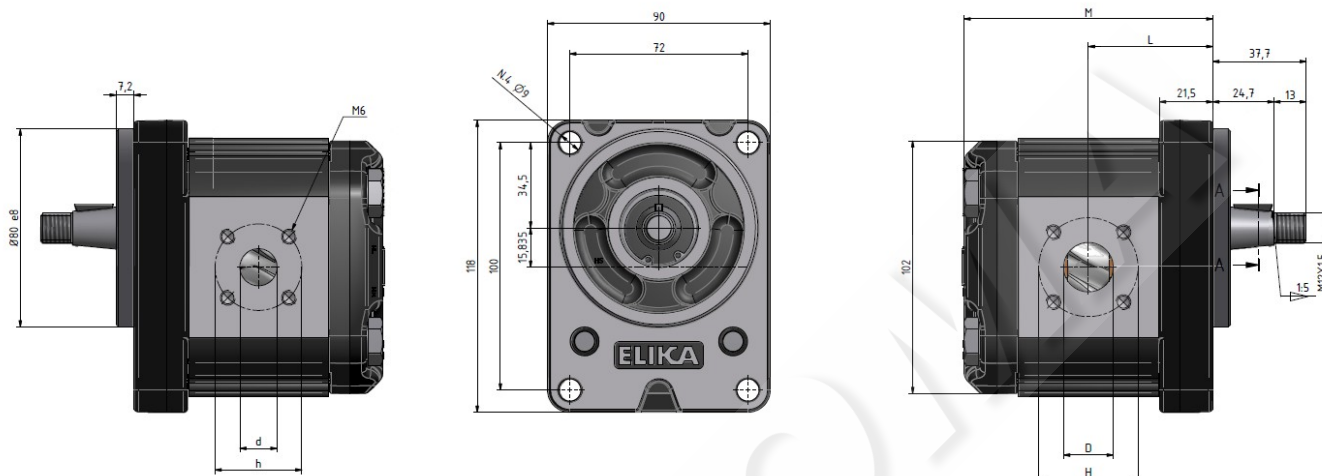

Pump Type	Displacement [cm ³ /rev]	Flow at 1500 rpm [l/min]	Operating pressures			Rotation speed		Noise at 1500 rpm *		Dimensions					
			P1 Max cont. [bar]	P2 Max intermittent [bar]	P3 Max peak [bar]	Minimum speed [rpm]	Maximum speed [rpm]	On recirculation [dBA]	at P1 [dBA]	L [mm]	M [mm]	D [mm]	H [mm]	d [mm]	H [mm]
ELI2BK1-D-7.0	7.0	10.5	280	295	310	500	4000	47	51	48.0	96.0	15	40	15	35
ELI2BK1-D-8.2	8.2	12.3	280	295	310	500	4000	47	52	49.0	98.0	15	40	15	35
ELI2BK1-D-9.6	9.6	14.5	280	295	310	500	4000	48	54	50.3	100.5	20	40	15	35
ELI2BK1-D-11.4	11.4	17.1	280	295	310	500	4000	48	55	51.8	103.5	20	40	15	35
ELI2BK1-D-14.0	14.0	21.0	260	275	290	500	4000	49	55	54.0	108.0	20	40	15	35
ELI2BK1-D-16.1	16.1	24.1	260	275	290	500	4000	49	56	55.8	111.5	20	40	15	35
ELI2BK1-D-17.8	17.8	26.7	260	275	290	500	4000	49	57	57.3	114.5	20	40	15	35
ELI2BK1-D-21.0	21.0	31.5	230	245	260	300	3500	49	57	60.0	120.0	20	40	15	35
ELI2BK1-D-23.7	23.7	35.5	230	245	260	300	3200	50	57	62.3	124.5	20	40	15	35
ELI2BK1-D-25.7	25.7	38.6	210	225	240	300	3000	50	57	64.0	128.0	20	40	15	35
ELI2BK1-D-28.0	28.0	42.1	200	215	230	300	2600	50	58	66.0	132.0	20	40	15	35
ELI2BK1-D-35.0	35.1	52.6	150	165	180	300	2200	50	58	72.0	144.0	20	40	15	35

Accessories supplied with the standard pump: woodruff key (code 522055), M12x1.5 hexagonal nut (code 523016), washer (code 523005). Standard ports: M6 threads depth 13 mm. Please strictly follow assembly and use indications given in this catalogue for top performance and longer life of the ELI Marzocchi series. It is also very important to equip the hydraulic system with a proper filtering unit.

ELI2BK2

Outlet

Inlet

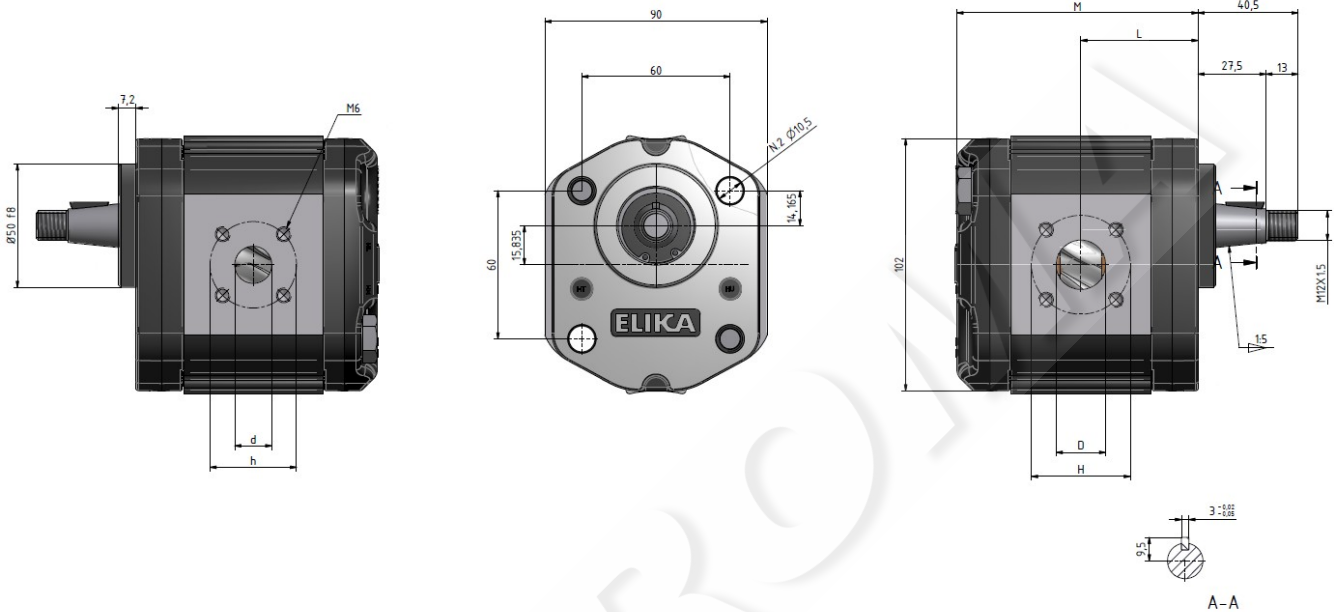

Pump Type	Displacement [cm ³ /rev]	Flow at 1500 rpm [l/min]	Operating pressures			Rotation speed		Noise at 1500 rpm *		Dimensions					
			P1 Max cont. [bar]	P2 Max intermittent [bar]	P3 Max peak [bar]	Minimum speed [rpm]	Maximum speed [rpm]	On recirculation [dBA]	at P1 [dBA]	L [mm]	M [mm]	D [mm]	H [mm]	d [mm]	H [mm]
ELI2BK2-D-7.0	7.0	10.5	280	295	310	500	4000	47	51	45.2	93.2	15	40	15	35
ELI2BK2-D-8.2	8.2	12.3	280	295	310	500	4000	47	52	46.2	95.2	15	40	15	35
ELI2BK2-D-9.6	9.6	14.5	280	295	310	500	4000	48	54	47.5	97.7	20	40	15	35
ELI2BK2-D-11.4	11.4	17.1	280	295	310	500	4000	48	55	49.0	100.7	20	40	15	35
ELI2BK2-D-14.0	14.0	21.0	260	275	290	500	4000	49	55	51.2	105.2	20	40	15	35
ELI2BK2-D-16.1	16.1	24.1	260	275	290	500	4000	49	56	53.0	108.7	20	40	15	35
ELI2BK2-D-17.8	17.8	26.7	260	275	290	500	4000	49	57	54.5	111.7	20	40	15	35
ELI2BK2-D-21.0	21.0	31.5	230	245	260	300	3500	49	57	57.2	117.2	20	40	15	35
ELI2BK2-D-23.7	23.7	35.5	230	245	260	300	3200	50	57	59.5	121.7	20	40	15	35
ELI2BK2-D-25.7	25.7	38.6	210	225	240	300	3000	50	57	61.2	125.2	20	40	15	35
ELI2BK2-D-28.0	28.0	42.1	200	215	230	300	2600	50	58	63.2	129.2	20	40	15	35
ELI2BK2-D-35.0	35.1	52.6	150	165	180	300	2200	50	58	69.2	141.2	20	40	15	35

Accessories supplied with the standard pump: woodruff key (code 522055), M12x1.5 hexagonal nut (code 523016), washer (code 523005). Standard ports: M6 threads depth 13 mm. To mount the pump: n° 2 M10 screws with a torque wrench setting fixed at 46±4 Nm. Please strictly follow assembly and use indications given in this catalogue for top performance and longer life of the ELI Marzocchi series. It is also very important to equip the hydraulic system with a proper filtering unit.

ELI2BK4

Outlet

Inlet

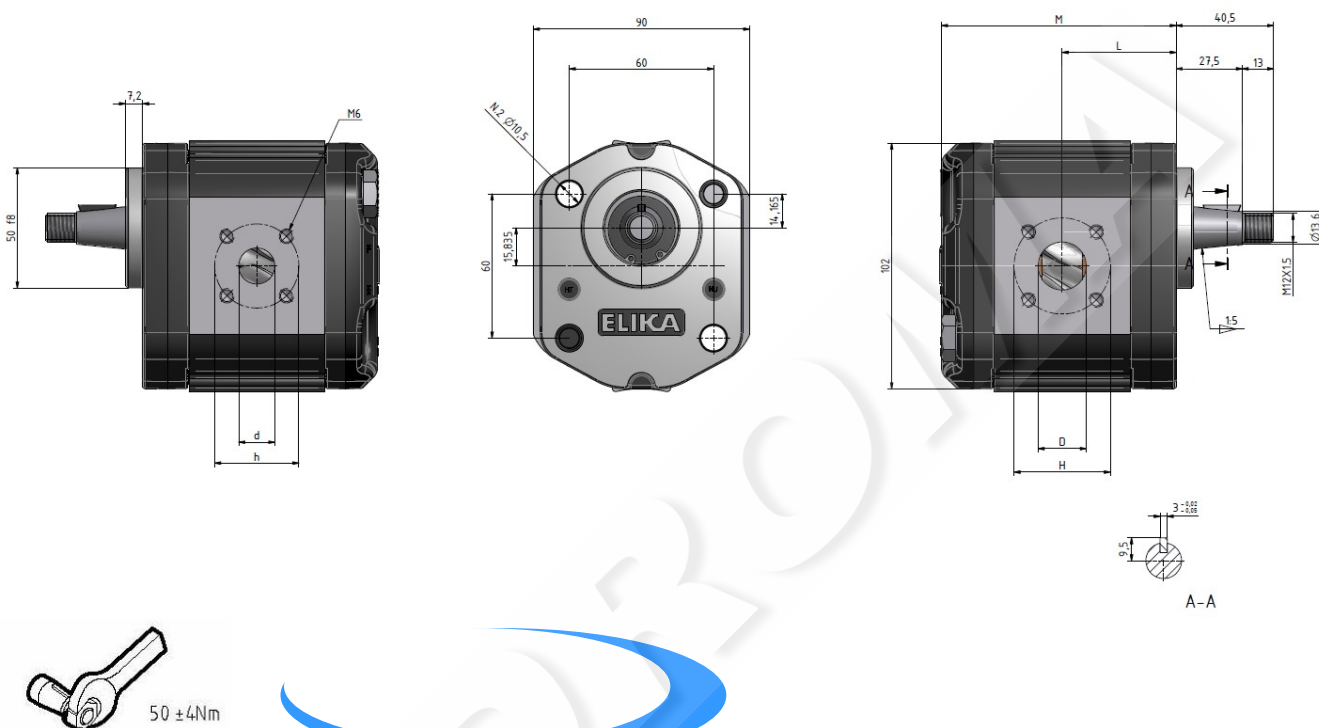

Pump Type	Displacement [cm ³ /rev]	Flow at 1500 rpm [l/min]	Operating pressures			Rotation speed		Noise at 1500 rpm *		Dimensions					
			P1 Max cont. [bar]	P2 Max intermittent [bar]	P3 Max peak [bar]	Minimum speed [rpm]	Maximum speed [rpm]	On recirculation [dBA]	at P1 [dBA]	L [mm]	M [mm]	D [mm]	H [mm]	d [mm]	H [mm]
ELI2BK4-D-7.0	7.0	10.5	280	295	310	500	4000	47	51	45.2	93.2	15	40	15	35
ELI2BK4-D-8.2	8.2	12.3	280	295	310	500	4000	47	52	46.2	95.2	15	40	15	35
ELI2BK4-D-9.6	9.6	14.5	280	295	310	500	4000	48	54	47.5	97.7	20	40	15	35
ELI2BK4-D-11.4	11.4	17.1	280	295	310	500	4000	48	55	49.0	100.7	20	40	15	35
ELI2BK4-D-14.0	14.0	21.0	260	275	290	500	4000	49	55	51.2	105.2	20	40	15	35
ELI2BK4-D-16.1	16.1	24.1	260	275	290	500	4000	49	56	53.0	108.7	20	40	15	35
ELI2BK4-D-17.8	17.8	26.7	260	275	290	500	4000	49	57	54.5	111.7	20	40	15	35
ELI2BK4-D-21.0	21.0	31.5	230	245	260	300	3500	49	57	57.2	117.2	20	40	15	35
ELI2BK4-D-23.7	23.7	35.5	230	245	260	300	3200	50	57	59.5	121.7	20	40	15	35
ELI2BK4-D-25.7	25.7	38.6	210	225	240	300	3000	50	57	61.2	125.2	20	40	15	35
ELI2BK4-D-28.0	28.0	42.1	200	215	230	300	2600	50	58	63.2	129.2	20	40	15	35
ELI2BK4-D-35.0	35.1	52.6	150	165	180	300	2200	50	58	69.2	141.2	20	40	15	35

Accessories supplied with the standard pump: woodruff key (code 522055), M12x1.5 hexagonal nut (code 523016), washer (code 523005). Standard ports: M6 threads depth 13 mm. To mount the pump: n°2 M10 screws with a torque wrench setting fixed at 46±4 Nm. Please strictly follow assembly and use indications given in this catalogue for top performance and longer life of the ELI Marzocchi series. It is also very important to equip the hydraulic system with a proper filtering unit.

ELI2BK7

Outlet

Inlet

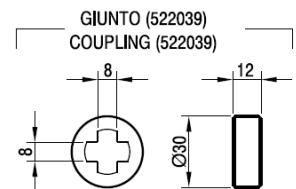
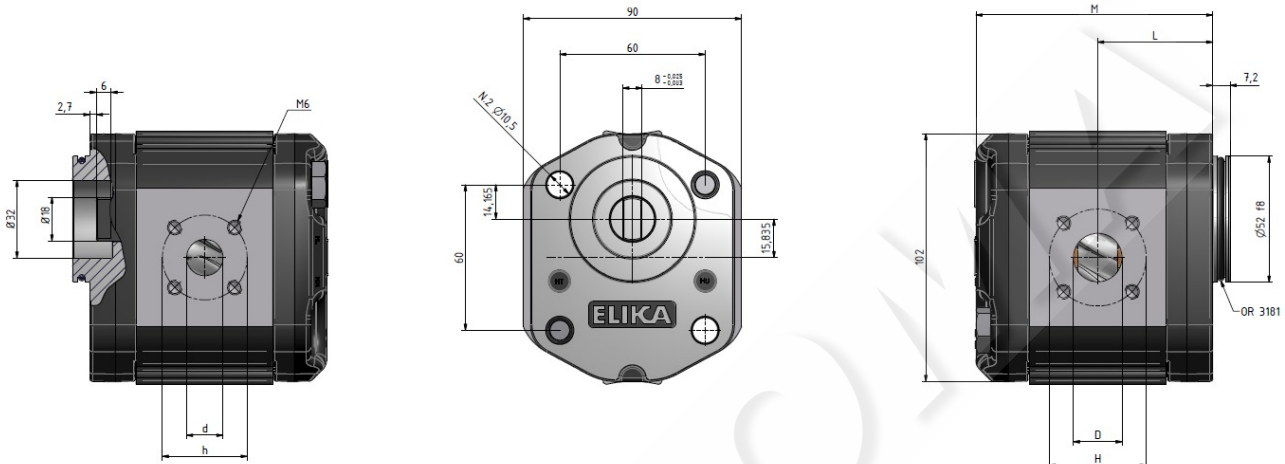

Pump	Displacement	Flow at 1500 rpm	Operating pressures			Rotation speed		Noise at 1500 rpm *		Dimensions					
			Type	1500 rpm	P1 Max cont.	P2 Max intermittent	P3 Max peak	Minimum speed	Maximum speed	On recirculation	at P1	L	M	D	H
	[cm ³ /rev]	[l/min]	[bar]	[bar]	[bar]	[rpm]	[rpm]	[dBA]	[dBA]	[mm]	[mm]	[mm]	[mm]	[mm]	[mm]
ELI2BK7-D-7.0	7.0	10.5	280	295	310	500	4000	47	51	45.2	93.2	15	40	15	35
ELI2BK7-D-8.2	8.2	12.3	280	295	310	500	4000	47	52	46.2	95.2	15	40	15	35
ELI2-BK7-D-9.6	9.6	14.5	280	295	310	500	4000	48	54	47.5	97.7	20	40	15	35
ELI2BK7-D-11.4	11.4	17.1	280	295	310	500	4000	48	55	49.0	100.7	20	40	15	35
ELI2BK7-D-14.0	14.0	21.0	260	275	290	500	4000	49	55	51.2	105.2	20	40	15	35
ELI2BK7-D-16.1	16.1	24.1	260	275	290	500	4000	49	56	53.0	108.7	20	40	15	35
ELI2BK7-D-17.8	17.8	26.7	260	275	290	500	4000	49	57	54.5	111.7	20	40	15	35
ELI2BK7-D-21.0	21.0	31.5	230	245	260	300	3500	49	57	57.2	117.2	20	40	15	35
ELI2BK7-D-23.7	23.7	35.5	230	245	260	300	3200	50	57	59.5	121.7	20	40	15	35
ELI2BK7-D-25.7	25.7	38.6	210	225	240	300	3000	50	57	61.2	125.2	20	40	15	35
ELI2BK7-D-28.0	28.0	42.1	200	215	230	300	2600	50	58	63.2	129.2	20	40	15	35
ELI2BK7-D-35.0	35.1	52.6	150	165	180	300	2200	50	58	69.2	141.2	20	40	15	35

Standard ports: M6 threads depth 13 mm. To mount the pump: n° 2 M10 screws with a torque wrench setting fixed at 46±4 Nm. Please strictly follow assembly and use indications given in this catalogue for top performance and longer life of the ELI Marzocchi series. It is also very important to equip the hydraulic system with a proper filtering unit.

FLANGE / FLANGES

ALBERI / SHAFTS

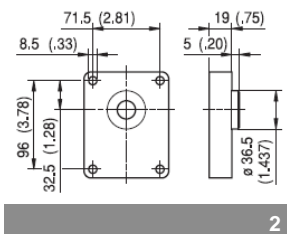

2

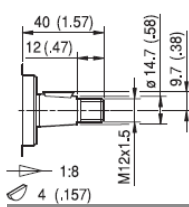

T0

Coppia Max
Max Torque 145 Nm

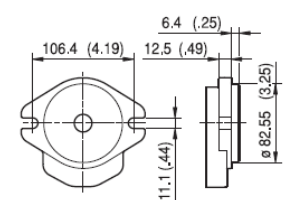

2A

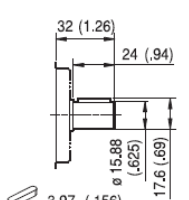

C1

Coppia Max
Max Torque 105 Nm

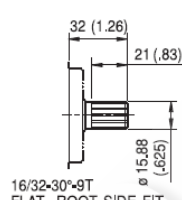

S1

16/32-30°9T
FLAT ROOT SIDE FIT
Coppia Max
Max Torque 110 Nm

FLANGE / FLANGES

ALBERI / SHAFTS

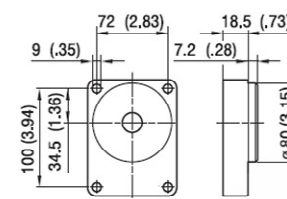

2BK1

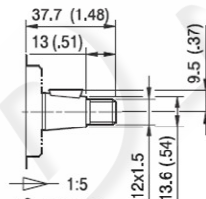

T1

Coppia Max
Max Torque 130 Nm

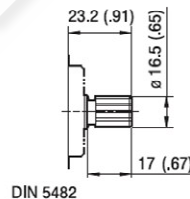

S3

DIN 5482
B17x14
Coppia Max
Max Torque 130 Nm

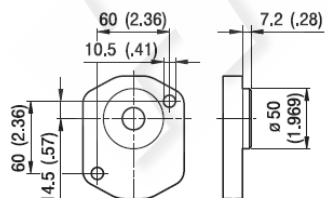

2BK2

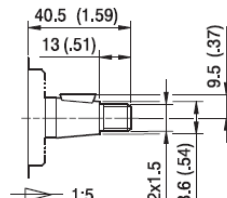

T2

Coppia Max
Max Torque 130 Nm

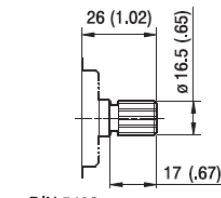

S4

DIN 5482
B17x14
Coppia Max
Max Torque 130 Nm

FLANGE / FLANGES

ALBERI / SHAFTS

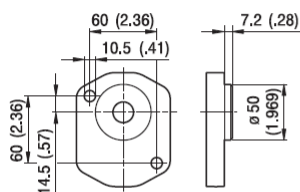

2BK4

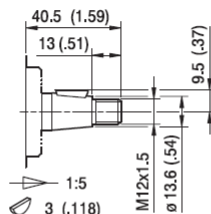

T2

Coppia Max
Max Torque 130 Nm

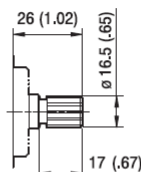

S4

DIN 5482
B17x14
Coppia Max
Max Torque 130 Nm

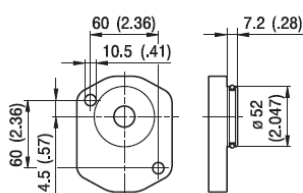

2BK7

OR 3181

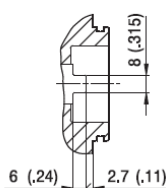

G0

Coppia Max
Max Torque 105 Nm

Maximum torque ratings are referred to ideal working conditions; such values may reduce based on the quality of joints and connections used..

PORTE / PORTS

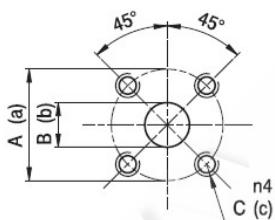

D

Tipo Type	Aspirazione Inlet			Mandata Outlet		
	A	B	C	a	b	c
ELI 7.0 ÷ 8.2	40	15	M6	35	15	M6
ELI 9.6 ÷ 35.0	40	19	M6	35	15	M6

Tightening torques for M6 screws 10 Nm.

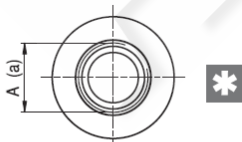

STANDARD SAE J1926/1

FA

Type Tipo	Aspirazione Inlet	Mandata Outlet
	A	a
ELI 7.0 ÷ 28.0	1 1/16-12 UNF	7/8-14 UNF
ELI 14.0 ÷ 35.0	1 5/16-12 UNF	7/8-14 UNF

Tightening torques for 7/8-14 UNF fitting 50 Nm.

Tightening torques for 1 1/16-12 UNF and 1 5/16-12 UNF fitting 60 Nm.



A reduction of body fatigue strength may occur if the pump is working at elevated and intermittent pressures

ELI2-7.0

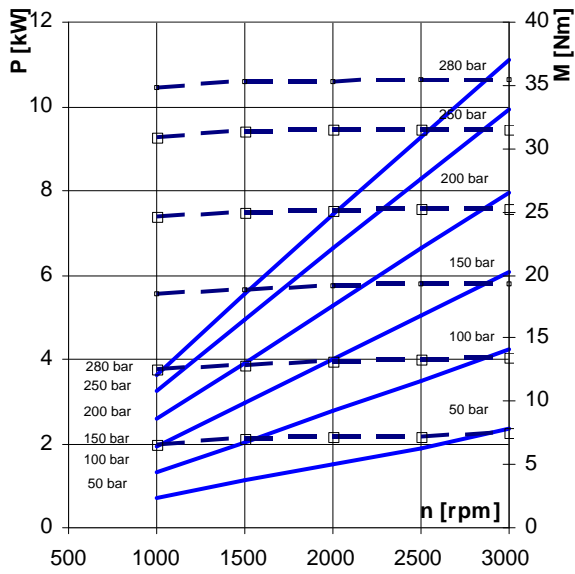

ELI2-8.2

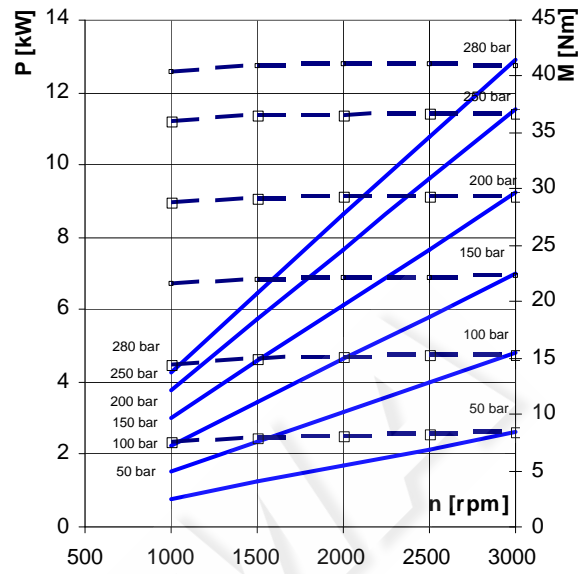

ELI2-9.6

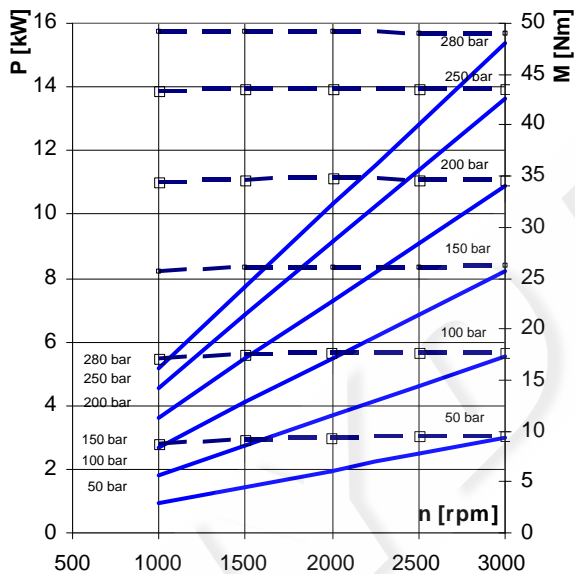

ELI2-11.4

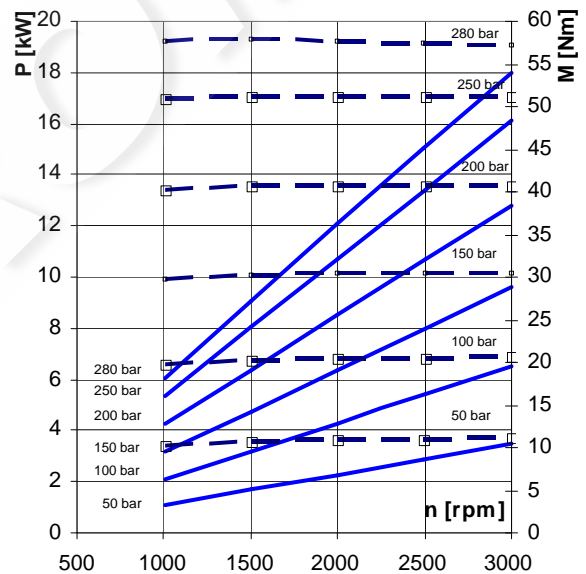

ELI2-14.0

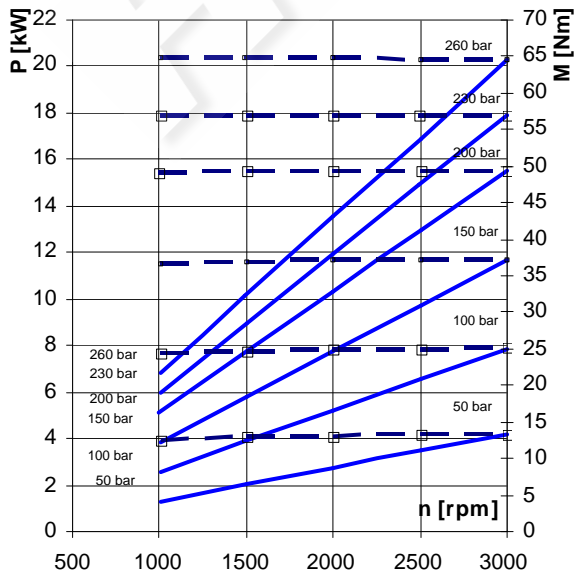

ELI2-16.1

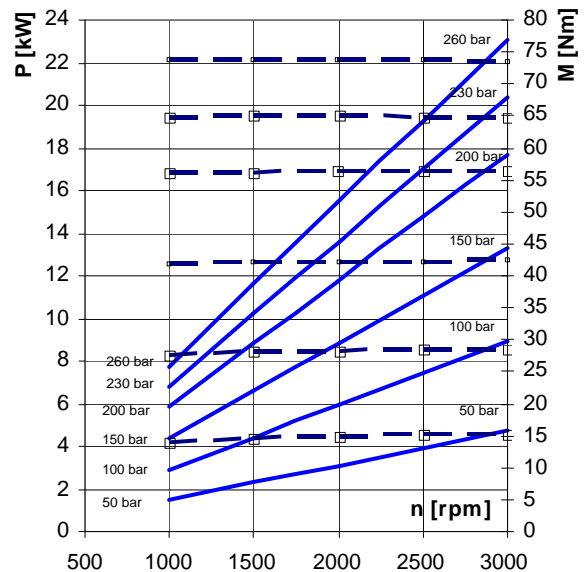

ELI2-17.8

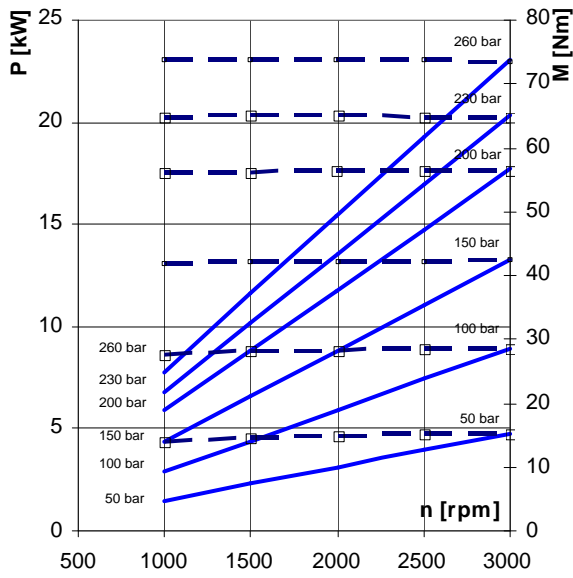

ELI2-21.0

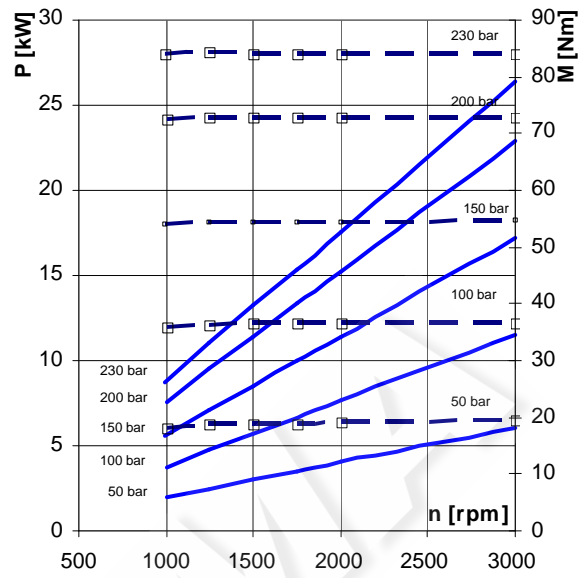

ELI2-23.7

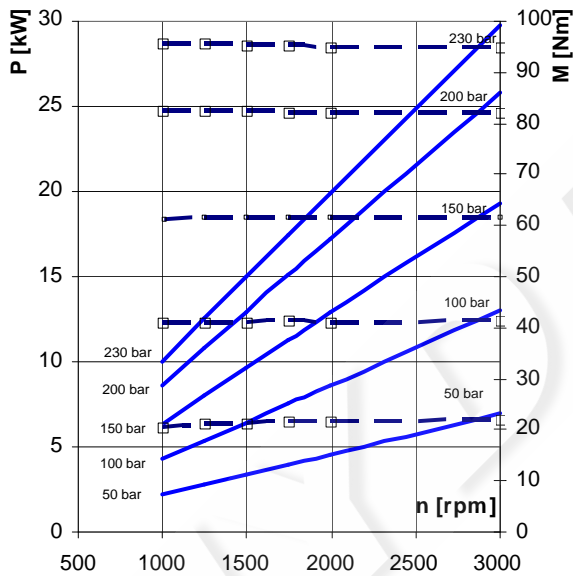

ELI2-25.7

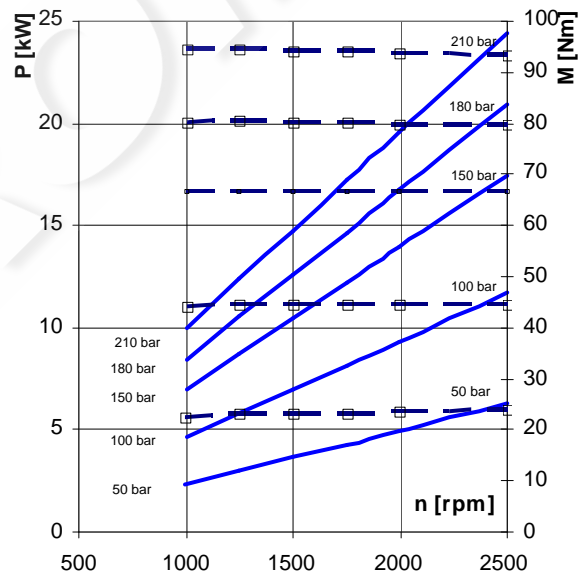

ELI2-28.0

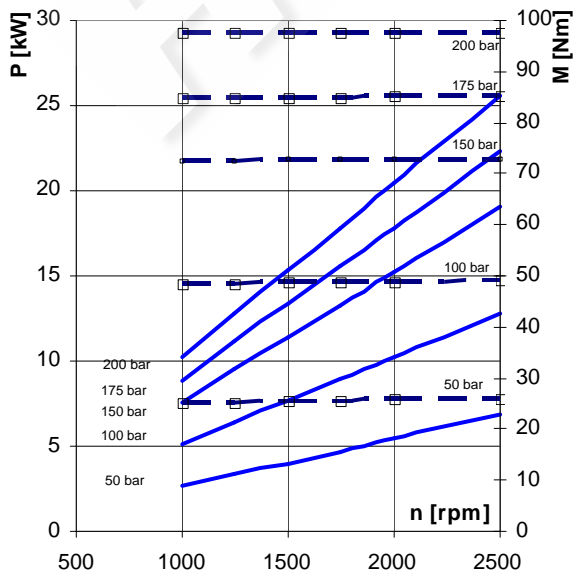

ELI2-35.0

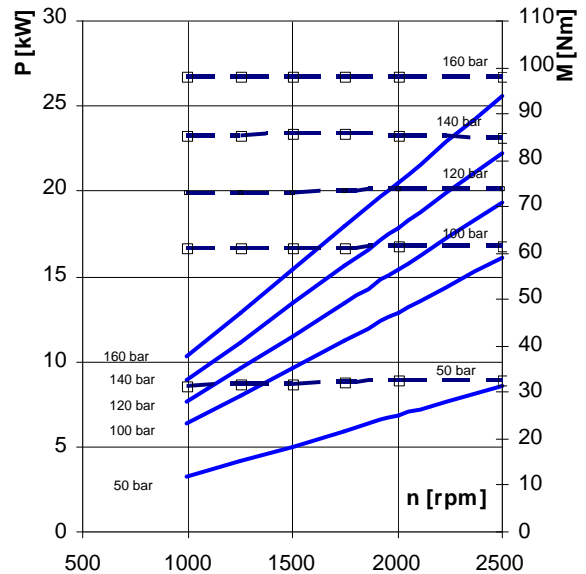

ELI2-7.0 / ELI2-8.2

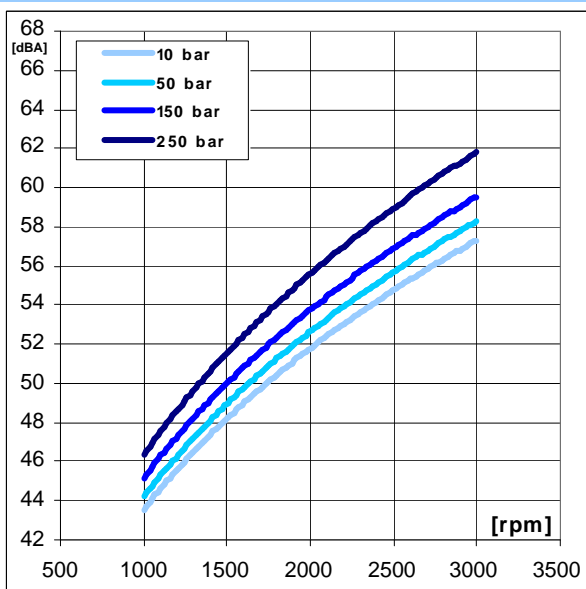

ELI2-9.6 / ELI2-11.4

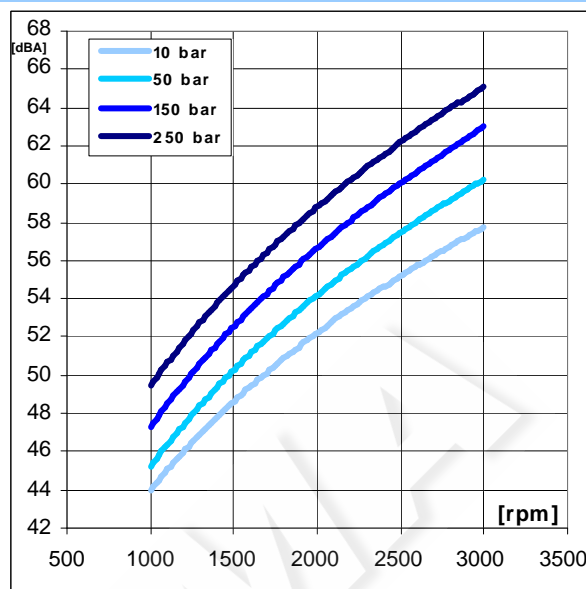

ELI2-14.0 / ELI2-16.1

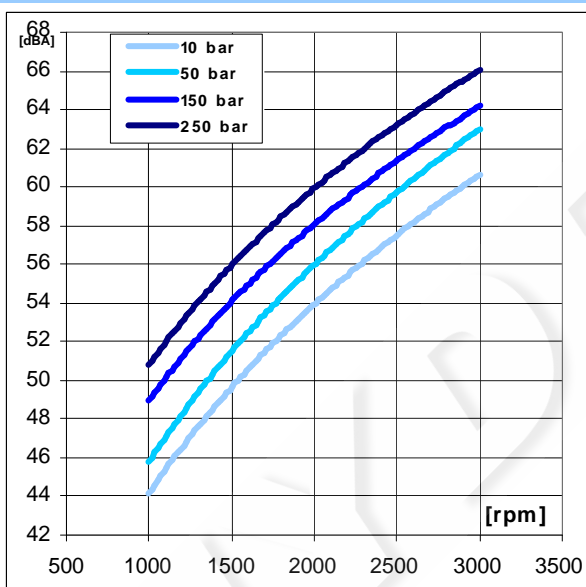

ELI2-17.8 / ELI2-21.0

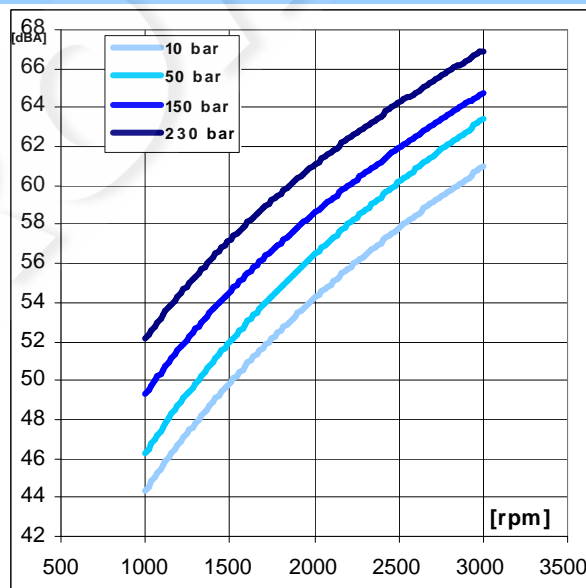

ELI2-23.7 / ELI2-25.7

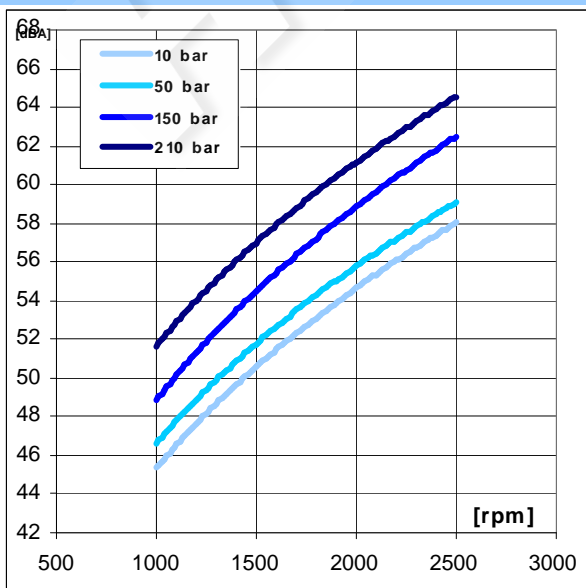

ELI2-28.0 / ELI2-35.0

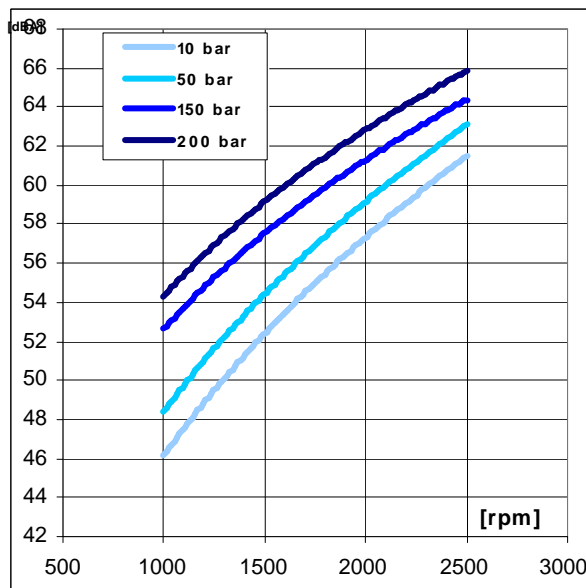



ELIKA[®]
by **MARZOCCHI**



YEAR 1961 – First pump by Marzocchi



YEAR 2011 – First ELIKA by Marzocchi

