

Part number:

HYDROMA

HYDRAULICKÉ SYSTÉMY

**HIDROMA
SYSTEMS**

UKŁADY HYDRAULICZNE

HYDROMA

ГИДРАВЛИЧЕСКИЕ СИСТЕМЫ

83 260/107 ED



DSE5 DIRECTIONAL VALVE WITH PROPORTIONAL CONTROL SERIES 10

**SUBPLATE MOUNTING
ISO 4401-05 (CETOP 05)**

**p max 320 bar
Q max 90 l/min**

MOUNTING INTERFACE

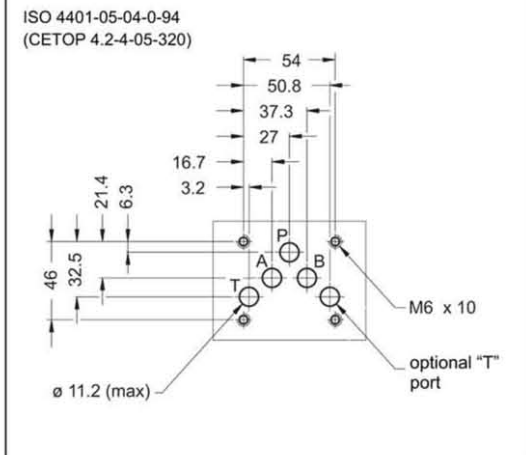

OPERATING PRINCIPLE

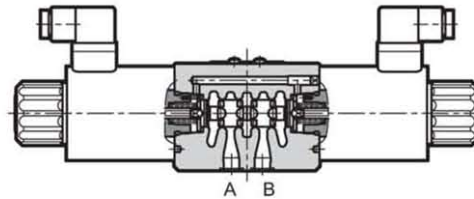

- The DSE5 valve is a directly operated directional control valve with electric proportional control and with ports in compliance with ISO 4401 standards (CETOP RP 121H).
- It is used for directional and speed control of the hydraulic actuators.
- Valve opening and hence flow rate can be modulated continuously in proportion to the current supplied to the solenoid.
- The valve can be controlled directly by a current control supply unit or by means of the relative electronic control units to exploit valve performance to the full (see paragraph 10).
- The DS5 valve is available in special version with Y external subplate drain port (see paragraph 9).

PERFORMANCES

(obtained with mineral oil with viscosity of 36 cSt at 50°C and electronic control cards)

Maximum operating pressure:		
- P - A - B ports	bar	320
- T port : standard version		210
version with Y port		320
Maximum flow with Δp 10 bar P-T	l/min	30 - 60
Step response	see paragraph 6	
Hysteresis	% of Q max	< 6%
Repeatability	% of Q max	< $\pm 1,5\%$
Electrical characteristics	see paragraph 5	
Ambient temperature range	°C	-10 / +50
Fluid temperature range	°C	-20 / +80
Fluid viscosity range	cSt	10 + 400
Fluid contamination degree	According to ISO 4406:1999 class 18/16/13	
Recommended viscosity	cSt	25
Mass: single solenoid valve	kg	4,4
double solenoid valve		5,9

HYDRAULIC SYMBOLS (typical)

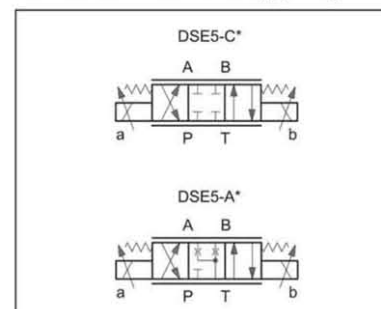

DSE5

SERIES 10

1 - IDENTIFICATION CODE

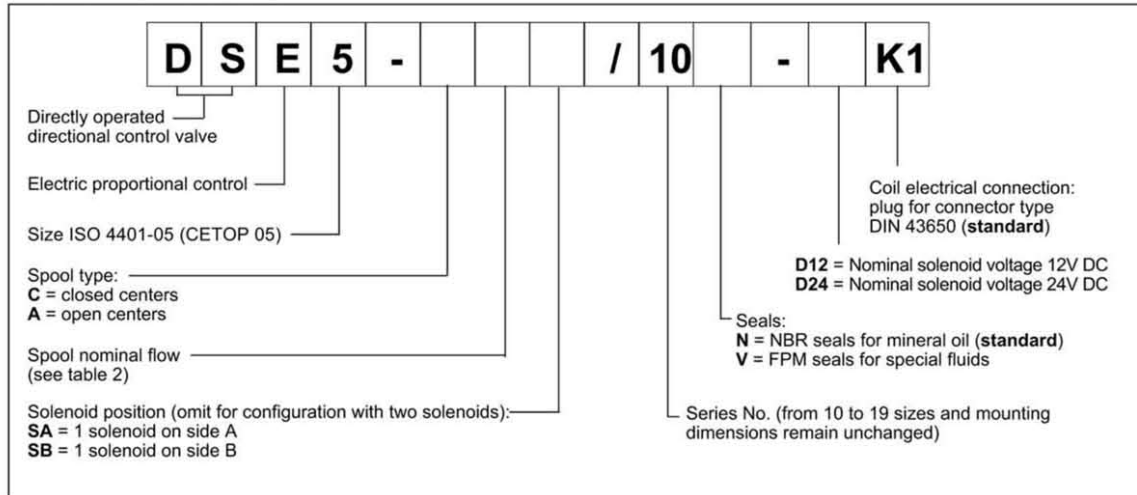

2 - CONFIGURATIONS

Valve configuration depends on the combination of the following elements:
number of proportional solenoids, spool type, nominal flow rate.

2 solenoids configuration:
3 positions with spring centering

"SA" configuration: 1 solenoid on side A.
2 positions (central + external) with spring centering

"SB" configuration: 1 solenoid on side B.
2 positions (central + external) with spring centering

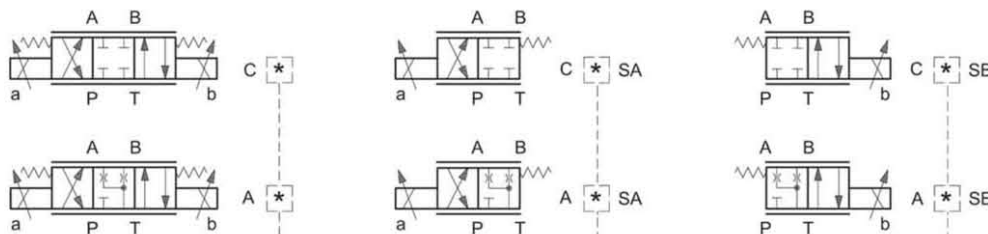

*	Controlled flow with Δp 10 bar P-T
30	30 l/min
60	60 l/min
60/30	60 (P-A) / 30 (B-T) l/min

DSE5

SERIES 10

3 - CHARACTERISTIC CURVES (values measured with viscosity of 36 cSt at 50°C with valves connected to the relative electronic control units)

Typical constant flow rate control curves at Δp according to current supply to solenoid (D24 version, maximum current 1600 mA), measured for the various spool types available.

The reference Δp values are measured between ports P and T on the valve.

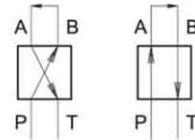

SPOOL TYPE C30

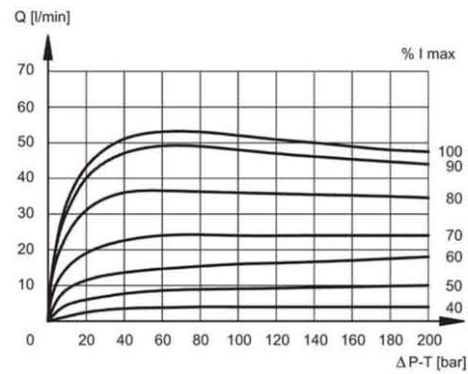
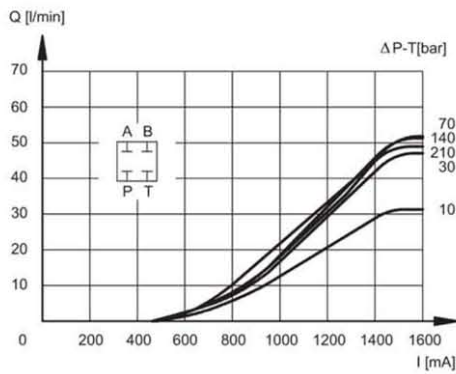

SPOOL TYPE C60

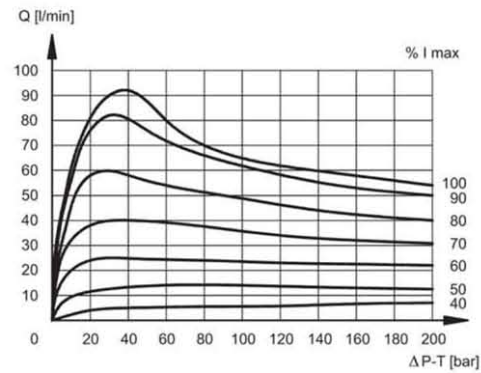
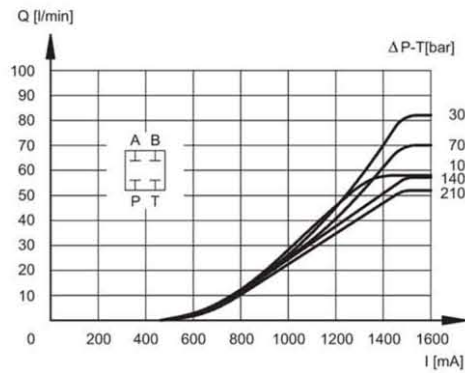

SPOOL TYPE A30

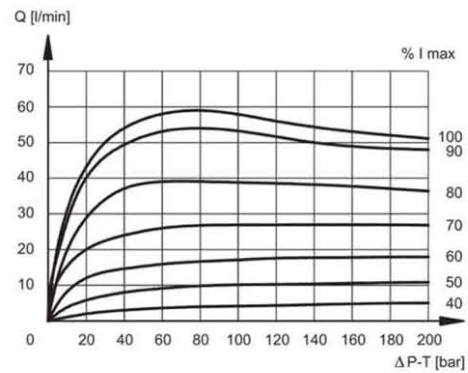
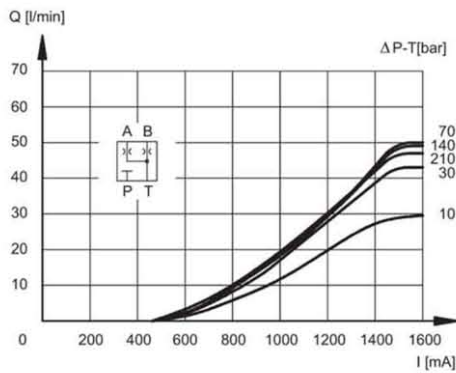

DSE5

SERIES 10

SPOOL TYPE A60

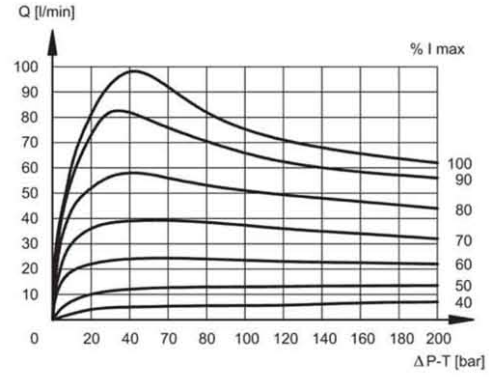
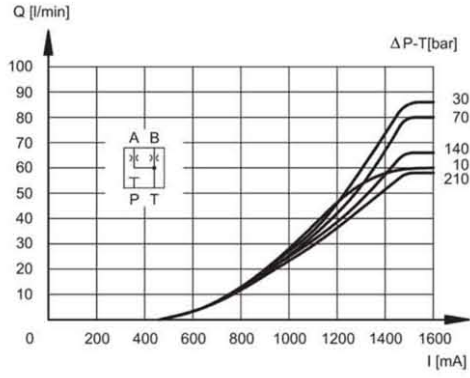

DSE5

SERIES 10

4 - HYDRAULIC FLUIDS

Use mineral oil-based hydraulic fluids HL or HM type, according to ISO 6743-4. For these fluids, use NBR seals (code N). For fluids HFDR type (phosphate esters) use FPM seals (code V).
 For the use of other fluid types such as HFA, HFB, HFC, please consult our technical department.
 Using fluids at temperatures higher than 80 °C causes a faster degradation of the fluid and of the seals characteristics.
 The fluid must be preserved in its physical and chemical characteristics.

5 - ELECTRICAL CHARACTERISTICS

Proportional solenoid

The proportional solenoid comprises two parts: tube and coil.

The tube, screwed to the valve body, contains the armature which is designed to maintain friction to a minimum thereby reducing hysteresis.

The coil is mounted on the tube secured by means of a lock nut.

It can be rotated through 360° depending on installation clearances.

NOMINAL VOLTAGE	V DC	12	24
RESISTANCE (at 20°C)	Ω	3 - 3.4	8.65
MAXIMUM CURRENT	A	2.6	1.6
DUTY CYCLE		100%	
ELECTROMAGNETIC COMPATIBILITY (EMC)		According to 89/336 CEE	
emissions	EN 50081-1		
immunity	EN 50082-2		
CLASS OF PROTECTION:		IP 65	
Atmospheric agents (CEI EN 60529)			

6 - STEP RESPONSE (measured with mineral oil with viscosity of 36 cSt at 50°C with the relative electronic control units)

Step response is the time taken for the valve to reach 90% of the set pressure value following a step change of reference signal.

The table shows typical response times tested with spool type C60 and $\Delta p = 20$ bar P-T.

REFERENCE SIGNAL STEP	0 → 100%	100 → 0%
Step response [ms] DSE5-A* DSE5-C*	50	70

7 - INSTALLATION

DSE5 valves can be installed in any position without impairing correct operation.

Ensure that there is no air in the hydraulic circuit.

Valves are fixed by means of screws or tie rods on a flat surface with planarity and roughness equal to or better than those indicated in the relative symbols. If minimum values are not observed fluid can easily leak between the valve and support surface.

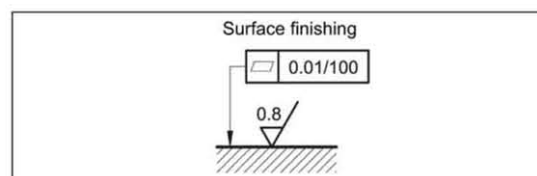

DSE5

SERIES 10

8 - OVERALL AND MOUNTING DIMENSIONS

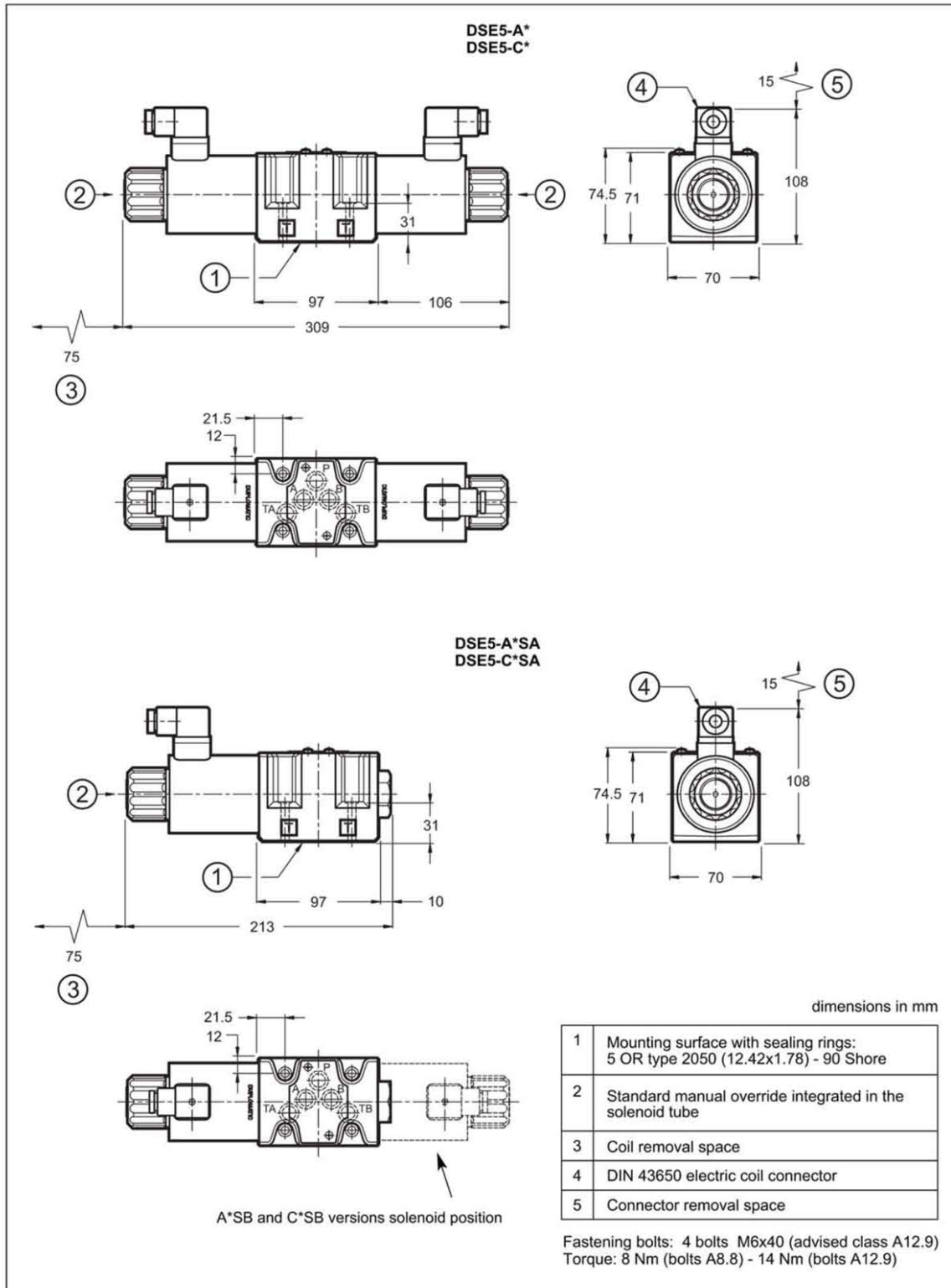

DSE5

SERIES 10

9 - SPECIAL VERSION WITH Y EXTERNAL SUBPLATE DRAIN PORT

Identification Code

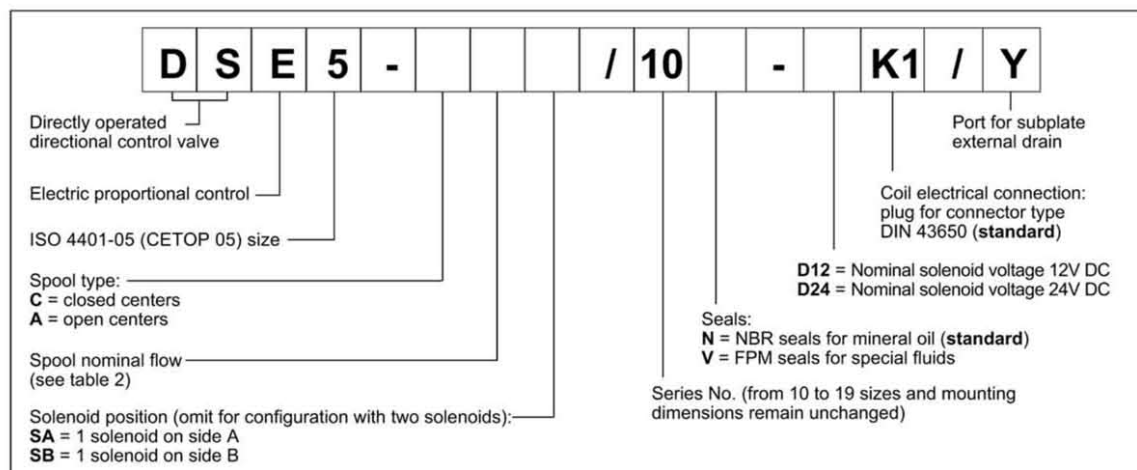

This version allows the operation with pressures up to 320 bar on the valve T port.

It is a drain port Y realized on the valve mounting interface in compliance with ISO 4401-05-05-0-94 (CETOP 4.2-4-R05). The Y port is connected with the solenoid chamber: in this way the tubes are not stressed by the pressure operating on the valve T port.

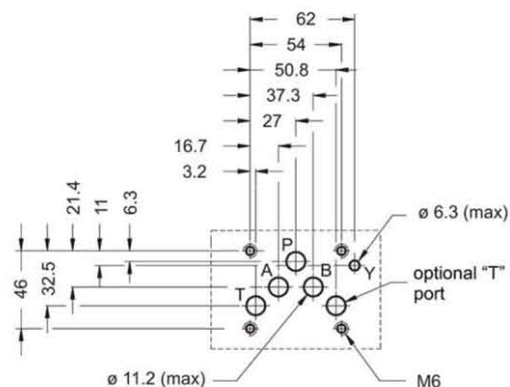

DSE5

SERIES 10

10 - ELECTRONIC CONTROL UNITS

DSE5- **SA (SB)

EDM-M131	for solenoid 24V DC	DIN EN 50022 rail mounting	see cat. 89 250
EDM-M151	for solenoid 12V DC		

DSE5- A* DSE5-C*

EDM-M231	for solenoid 24V DC	DIN EN 50022 rail mounting	see cat. 89 250
EDM-M251	for solenoid 12V DC		

11 - SUBPLATES (see cat. 51 000)

Type PMD4-AI4G with rear ports 1/2" BSP
Type PMD4-AL4G with side ports 1/2" BSP