

Part number:

089-10003

HYDROMA

HYDRAULICKÉ SYSTÉMY

**HIDROMA
SYSTEMS**

UKŁADY HYDRAULICZNE

HYDROMA

ГИДРАВЛИЧЕСКИЕ СИСТЕМЫ

Data sheet

Thermostatically operated cooling water valves Type AVTA

Features



AVTA

- Insensitive to dirt
- Insensitive to water pressure
- Needs no power supply - self acting
- Opens on rising sensor temperature
- Differential pressure: 0 to 10 bar
- Max. working pressure: 16 bar
- Max. test pressure: 25 bar
- Max. pressure on sensor: 25 bar
- Stainless Steel version available
- The valves are pressure-relieved, i.e. the degree of opening is not affected by differential pressure Δp (pressure drop).
- The regulation range is defined for the point at which the valve begins to open.

Introduction

Thermostatically operated valves are used for the infinite, proportional regulation of flow quantity, depending on the setting and the sensor temperature.

The Danfoss range of thermostatic valves includes a series of industrial products for both refrigeration and heating regulation. The valves are self-acting, i.e. they operate without the supply of auxiliary energy such as electricity or compressed air.

Because the valves constantly match flow quantity to demand, they are especially suitable for temperature regulation.

The required temperature is maintained constant with no overconsumption of:

- cooling water in cooling systems,
- hot water or steam in heating systems.

Contents

	Page
How it works	2
Materials	2
AVTA for neutral media	3
Ordering	4
Dimensions and weights	4
AVTA SS for aggressive media	5
Ordering	6
Dimensions	6
Installation	7
Sensor installation	7
Spare parts and accessories	8
Sizing	9
Diagrams	10
Options	11

How it works

Thermostatic valves consist of three main elements:

- Setting section with knob, reference spring and setting scale.

- Valve body with orifice, closing cone and sealing elements.

- Hermetically sealed thermo-static element with sensor, bellows and charge.

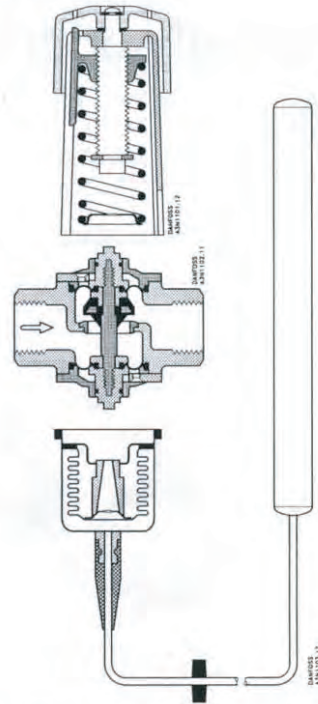

When the three elements are built together, the valve is installed and the sensor is located at the point where the temperature is to be regulated, the function sequence is as follows:

1. A temperature-dependent pressure - charge vapour pressure - builds up in the sensor.
2. This pressure is transferred to the valve via the capillary tube and bellows and acts as an opening or closing force.
3. The knob on the setting section and the spring exert a force that acts counter to the bellows.

4. When balance is created between the two opposing forces, the valve spindle remains in its position.

5. If the sensor temperature - or the settings - is changed, the point of balance becomes displaced and the valve spindle moves until balance is re-established, or the valve is fully open or closed.

6. On sensor temperature change, the flow quantity change is approximately proportional.

The illustrations show an AVTA cooling water valve, but the function principle applies to all types of thermostatic valves.

Materials

No.	Description	Material
1	Spindle	Brass W.no. 2.0401
2	Diaphragms	Rubber - ethylene - propylene (EPDM).
3	Valve body and other metal parts	Forged brass W.no. 2.0402
4	Valve cone	Nitrile rubber (NBR)
5	Valve seat	Stainless steel W.no. 1.4305/AISI 303
6	Sensor	Copper W.no. 2.0090
7	Capillary tube gland	Nitrile rubber (NBR) Brass W.no. 2.0321 / 2.0401

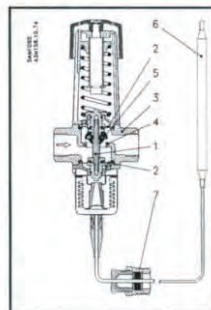

Ordering AVTA with adsorption charge

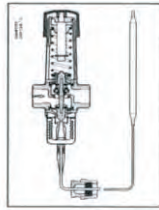

- Wide regulating range
- Can be installed in any position as far as orientation and - temperature are concerned
- Withstands up to +130°C sensor temperature
- Small sensor dimensions - Ø 9,5 x 160 mm
- Max. pressure on sensor 25 bar.

The charge consists of active carbon and CO₂ which is adsorbed on falling sensor temperature and thereby produce pressure changes in the element.

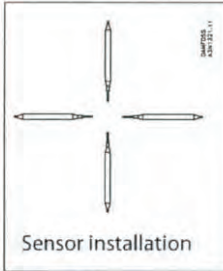

Connection ISO 228	Regulating range [°C]	Max.temp. sensor [°C]	k _v value (m ³ /h at Δp = 1 bar)	Capillary tube length [m]	Type	Code no. ¹⁾
G 3/8	+10 to +80	130	1.4	2.3	AVTA 10	003N1144
G 1/2			1.9		AVTA 15	003N0107
G 3/4			3.4		AVTA 20	003N0108
G 1			5.5		AVTA 25	003N0109

1) Code no. covers complete valve incl. capillary tube gland.
Immersion pockets, see "Spare parts and accessories", page 8.

Ordering AVTA with universal charge

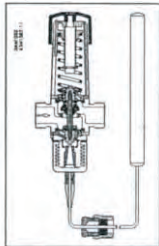

- Sensor dimensions Ø 18 x 210 mm
- Sensor can be installed colder or warmer than the valve
- Sensors must be orientated as shown in sketch below
- Max. pressure on sensor 25 bar.

The charge is a mix of liquid and gas where the liquid surface (regulating point) is always inside the sensor. Wich charge medium is used depends on the regulation range.



Connection ISO 228	Regulating range [°C]	Max.temp. sensor [°C]	k _v value (m ³ /h at Δp = 1 bar)	Capillary tube length [m]	Type	Code no. ¹⁾		
G 3/8	+0 to +30	57	1.4	2.0	AVTA 10	003N1132		
G 1/2			1.9		AVTA 15	003N2132		
G 3/4			3.4		AVTA 20	003N3132		
G 1			5.5		AVTA 25	003N4132		
G 3/8	+25 to +65	90	1.4	2.0	AVTA 10	003N1162		
G 1/2			1.9	2.0	AVTA 15	003N2162		
G 1/2			1.9	2.0 (armoured)	AVTA 15	003N0041		
G 3/4			3.4	2.0	AVTA 20	003N3162		
G 3/4			3.4	5.0	AVTA 20	003N3165		
G 3/4			3.4	2.0 (armoured)	AVTA 20	003N0031		
G 1			5.5	2.0	AVTA 25	003N4162		
G 1			5.5	2.0 (armoured)	AVTA 25	003N0032		
G 1			5.5	5.0	AVTA 25	003N4165		
G 3/8			+50 to +90	125	1.4	2.0	AVTA 10	003N1182
G 1/2					1.9	2.0	AVTA 15	003N2182
G 3/4	3.4	2.0			AVTA 20	003N3182		
G 1	5.5	2.0			AVTA 25	003N4182		
G 1	5.5	3.0			AVTA 25	003N4183 ²⁾		

1) Code no. covers complete valve incl. capillary tube gland.
2) A Ø 2 mm bypass is drilled in the valve body.
Immersion pockets, see "Spare parts and accessories", page 8.

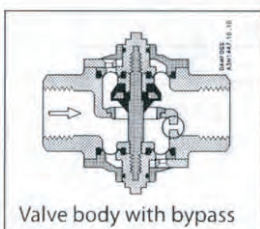

Valve body with bypass

Ordering
AVTA with mass charge

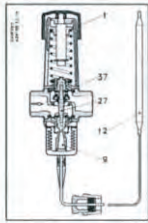

- Small sensor dimensions - Ø 9,5 x 190 mm
 - Short time constant
 - Sensor must always be installed warmer than the valve
 - Max. pressure on sensor 25 bar
- The Charge is a mix of liquid and gas. Due to the volumetric conditions the sensor must be installed warmer than the valve, since the liquid Surface (regulation point) must be in the Sensor.

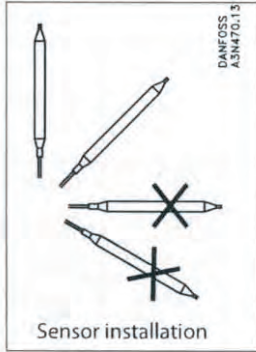

Connection ISO 228	Regulating range [°C]	Max.temp. sensor [°C]	k_v value (m ³ /h at $\Delta p = 1$ bar)	Capillary tube length [m]	Type	Code no. ¹⁾
G 1/2	+0 to +30	57	1.9	2.0	AVTA 15	003N0042
G 3/4			3.4		AVTA 20	003N0043
G 1/2	+25 to +65	90	1.9	2.0	AVTA15	003N0045
G 1/2			1.9	2.0 (armoured)	AVTA 15	003N0299
G 1/2			1.9	5.0	AVTA 15	003N0034
G 3/4			3.4	2.0	AVTA 20	003N0046
G 1			5.5	2.0	AVTA 25	003N0047

1) Code no. covers complete valve incl. capillary tube gland.

Dimensions and weights

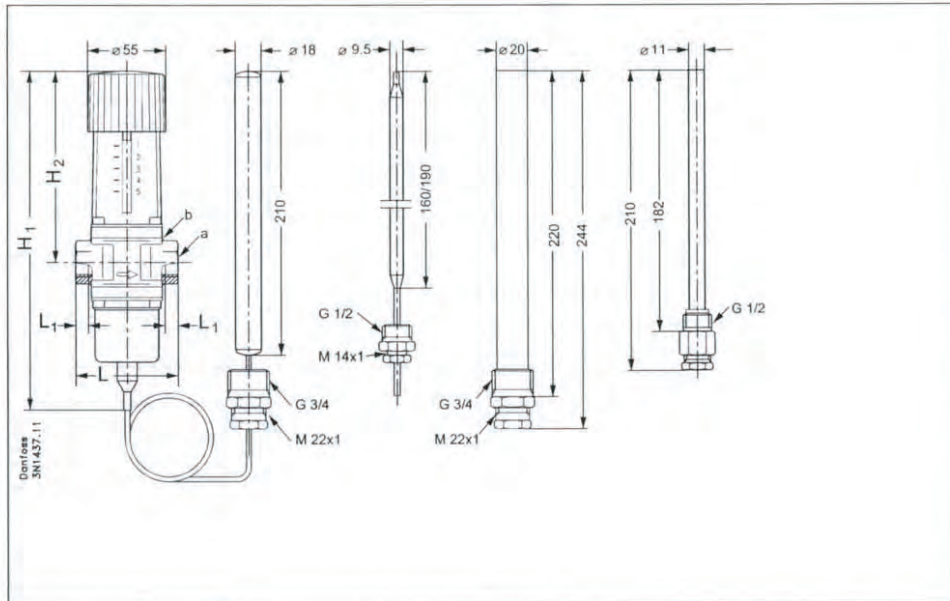

Type	H ₁ [mm]	H ₂ [mm]	L [mm]	L ₁ [mm]	a	b [mm]	Weight [kg]
AVTA 10	240	133	72	14	G 3/8	○ 27	1.45
AVTA 15	240	133	72	14	G 1/2	○ 27	1.45
AVTA 20	240	133	90	16	G 3/4	○ 32	1.50
AVTA 25	240	138	95	19	G 1	○ 41	1.65

Features

**AVTA SS for aggressive media.**

- Insensitive to dirt
- Insensitive to water pressure
- Needs no power supply - self acting
- Opens on rising sensor temperature
- Differential pressure: 0 to 10 bar
- Max. working pressure: 16 bar
- Max. test pressure: 25 bar
- Max. pressure on sensor: 25 bar
- The valves are pressure-relieved, i.e. the degree of opening is not affected by differential pressure Δp (pressure drop).
- The regulation range is defined for the point at which the valve begins to open.

Application

AVTA SS for aggressive media.

A valve body in stainless steel means that the valve can be used for aggressive media in such applications as the marine sector and the chemical industry.

AVTA SS valves have an adsorption charge as standard.

Materials

No.	Description	Material
1	Spindle	Stainless steel W.no. 1.4539 (EN 10088); UNS N 08904
2	Diaphragms	Rubber - ethylene - propylene (EPDM).
3	Valve body	Stainless steel W.no. 1.4581 (EN10213-4); AISI 318
4	Valve cone	Nitrile rubber (NBR)
5	Sensor	Copper (DIN 1787) W.no. 2.0090
6	Capillary tube gland	Nitrile rubber (NBR), Brass (DIN 17660) W.no. 2.0321 / 2.0401

Ordering
AVTA in stainless steel
with adsorption charge

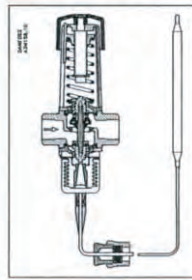

- Wide regulating range
 - Can be installed in any position as far as orientation and - temperature are concerned
 - Withstands up to +130°C sensor temperature
 - Small sensor dimensions
 - Ø 9,5 x 160 mm
 - Max. pressure on sensor 25 bar.
- The charge consists of active carbon and CO₂ which is adsorbed on falling sensor temperature and thereby produce pressure changes in the element.

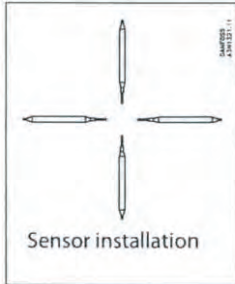

Connection ISO 228	Regulating range [°C]	Max.temp. sensor [°C]	k _v value (m ³ /h at Δp = 1 bar)	Capillary tube length [m]	Type	Code no. ¹⁾
G 1/2	+10 to +80	130	1.9	2.3	AVTA 15	003N2150
G 3/4			3.4		AVTA 20	003N3150
G 1			5.5		AVTA 25	003N4150

1) Code no. covers complete valve incl. capillary tube gland.

Immersion pockets, see "Spare parts and accessories", page 8.

Dimensions

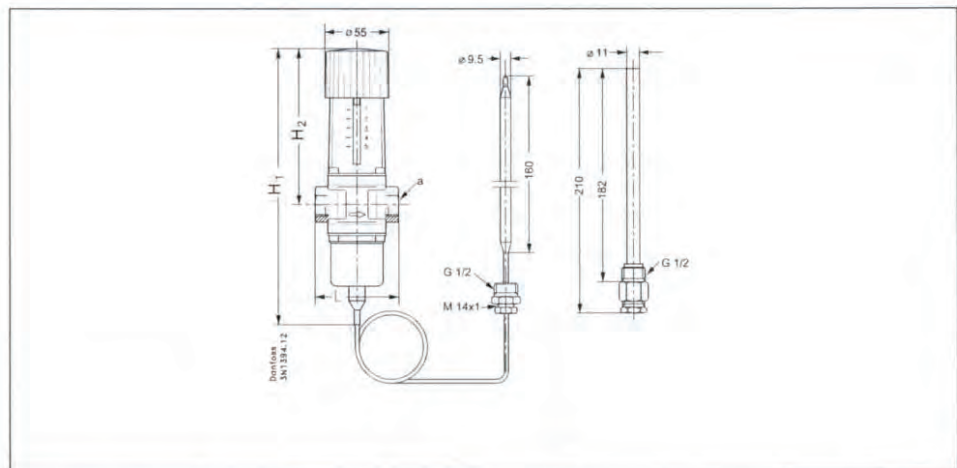

Type	H ₁ [mm]	H ₂ [mm]	L [mm]	a ISO 228/1
AVTA 15	240	133	72	G 1/2
AVTA 20	240	133	90	G 3/4
AVTA 25	240	138	95	G 1

Installation

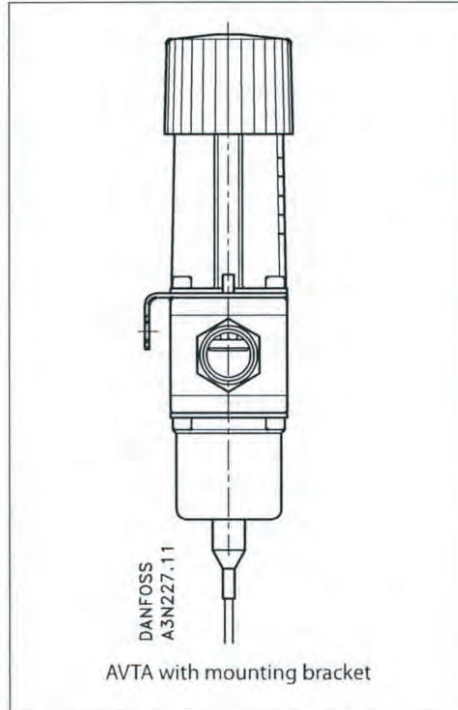

The valves can be installed in any position. An arrow on the valve body indicates the direction of flow. AVTA valves are also marked so that the letters RA can be read straightforwardly when the valve is held as shown. The installation of an FV filter ahead of the valve is recommended - see separate data sheet DKACV.PD.600.B.

Capillary tube
Install the capillary tube without sharp bends (no "kinks"). Relieve the capillary tube at the ends. Relief is important where vibration might occur.

Note
Where AVTA is used, the sensor must be able to react to variations in cooling water temperature on system start. Therefore a bypass line with a shut-off valve might be necessary to ensure flow at the sensor during start-up.

If a mounting bracket is used - see "Spare parts and accessories" page 8 - it must always be between valve body and setting section (see illustration).





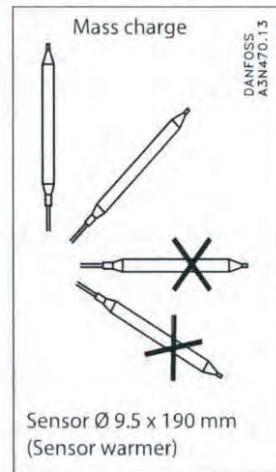
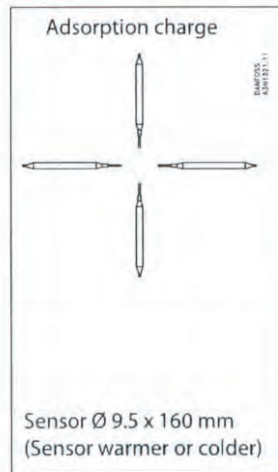

Sensor installation

If an immersion sensor is installed, the use of heat-conductive compound is recommended. This will reduce reaction time. See "Spare parts and accessories", page 8.

AVTA with small sensor (Ø 9.5 x 190 mm) must always be installed in the flow line, where the regulated liquid is coldest ("sensor warmer").



Accessories

	Designation	Description	Code no.
	Immersion sensor max. pressure 50 bar L = 220 mm	Brass for Ø 18 sensor G 3/4	003N0050
		Brass for Ø18 mm sensor 3/4 - 14 NPT	003N0051
		18/8 steel ¹⁾ for Ø18 sensor G 3/4	003N0192
	Immersion sensor max. pressure 50 bar L = 182 mm	Brass for Ø 9.5 sensor G 1/2	017-4367
		18/8 steel ¹⁾ for Ø 9.5 sensor G 1/2	003N0196
	Immersion sensor max. pressure 50 bar L = 182 mm	18/8 steel ¹⁾ for Ø 9.5 sensor G 1/2 For armoured capillary tube	003N0199
	Mounting bracket	For AVTA	003N0388
	Heat-conductive compound	5 gram tube	041E0110
		0.8 kg	041E0111
	1 set off nitrile diaphragm for mineral oil	For AVTA 10/15	003N0445
		For AVTA 20	003N0446
		For AVTA 25	003N0447
	Capillary tube gland	G 1/2	017-4220
		G 3/4	003N0155
		3/4 - 14 NPT	003N0056

1) W. no. 1.4301

Spare parts

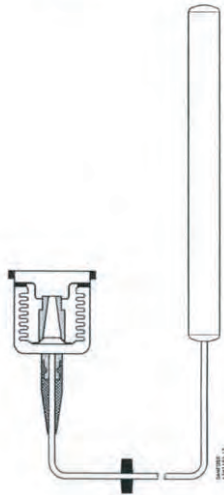

Service elements for AVTA

	Temperature range [°C]	Capillary tube length [m]	Code no.
Adsorption charge - sensor Ø 9.5 x 160 mm	+10 → +80	2.3	003N0278
Universal charge - sensor Ø 18 x 210 mm	0 → +30	2	003N0075
		5	003N0077
	+25 → +65	2	003N0078
		5	003N0080
		2 (armoured)	003N0063
	+50 → +90	3	003N0079
2		003N0062	
Mass charge - sensor Ø9.5 x 190 mm	0 → +30	3	003N0089
		2	003N0066
	+25 → +65	2	003N0091
		5	003N0068

Sizing

When sizing and selecting thermostatic valves, it is most important to ensure that the valve is able to give the necessary quantity of cooling water at any time, irrespective of the load. Therefore, to select a suitable size of valve it is necessary to know the precise amount of cooling required. On the other hand, to avoid the risk of unstable regulation (hunting), the valve should not be oversized.

The type of charge must be selected on the basis of the temperature to be maintained, and on an assessment of the characteristics of each type, as described in the foregoing.

In general the aim should be to select the smallest valve capable of giving the required flow.

It is also recommended that the temperature range be chosen so that the required sensor temperature lies in the middle of the regulation range.

To help fine-setting the valve, a thermometer should be installed near the sensor.

Valve size

The following data are used when selecting valve size:

- Required cooling water flow, Q [m^3/h]
- Temperature rise in cooling water, $[\Delta t]$ ($^{\circ}\text{C}$)
- Differential pressure across valve, $[\Delta p]$ (bar).

With fully open valve the differential pressure should be around 50% of the total pressure drop across the cooling system.

The diagrams on page 10 are intended to make valve sizing easier.

Fig. 1 - Relation between heat quantity [kW] and cooling water quantity

Fig. 2 - Graphs of k_v values

Fig. 3 - Valve operating range

Fig. 4 - Flow quantities as a function of pressure drop $[\Delta p]$

Example

A cooling water valve must be selected for the temperature regulation of a vacuum pump.

Since direct regulation of the oil temperature is required, an AVTA valve is suitable. The sensor position is horizontal - and small dimensions are desired.

Given data:

- Necessary cooling at full load 10 kW.
- Oil temperature to be maintained constant at $+45^{\circ}\text{C}$
- Cooling water $p_1 = 3$ bar
- Outlet $p_3 = 0$ bar

$$- p_2 = \frac{p_1 + p_3}{2} \quad (\text{guess})$$

- Cooling water temperature $t_1 = +20^{\circ}\text{C}$
- Outlet temperature $t_2 = +30^{\circ}\text{C}$

1. The graphs in fig. 1 can be used to find the necessary cooling water quantity at $\Delta t = 10^{\circ}\text{C}$ ($+30^{\circ}\text{C} - +20^{\circ}\text{C}$) to $0.85 \text{ m}^3/\text{h}$.

The graphs in fig. 2 show the necessary k_v value for $0.85 \text{ m}^3/\text{h}$ with

$$\Delta p = p_1 - p_2 = 3 - 1.5 = 1.5 \text{ bar for } 0.7 \text{ m}^3/\text{h}.$$

The columns in fig. 3 show that all four AVTA valves can be used, but in practice an AVTA 10 or 15 shall be selected, so the necessary water flow is in the middle of the regulating range.

The above considerations apply to both AVTA and FJVA types.

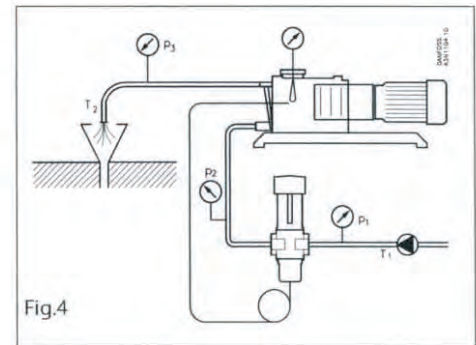

Operating conditions and other product requirements in this example mean that a valve with adsorption charge is the correct choice. The temperature range $+10 \rightarrow +80^{\circ}\text{C}$ is in order.

The table at the top of page 3 shows AVTA 10, code no. 003N1144, or AVTA 15, code no. 003N0107. Both fulfil the requirements named.

In many applications, installation conditions make the use of sensor pockets advisable.

"Accessories" on page 8 gives the code nos. for sensor pockets for $\varnothing 9.5$ mm sensors in brass and stainless steel: 017-4367 and 003N0196, respectively.

Sizing

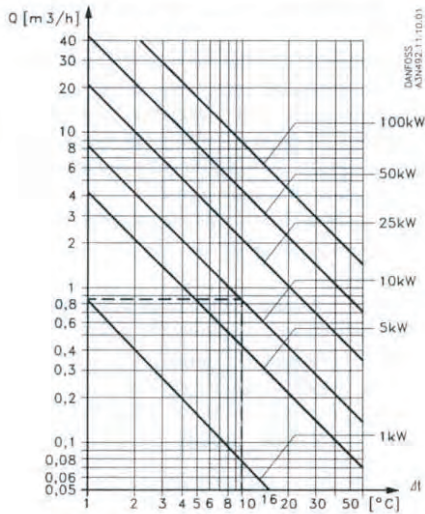

Fig. 1 Heating or cooling with water. Example: Necessary cooling output 10 kW with $\Delta t = 10^{\circ}C$ Required flow $0.85 m^3/h$.

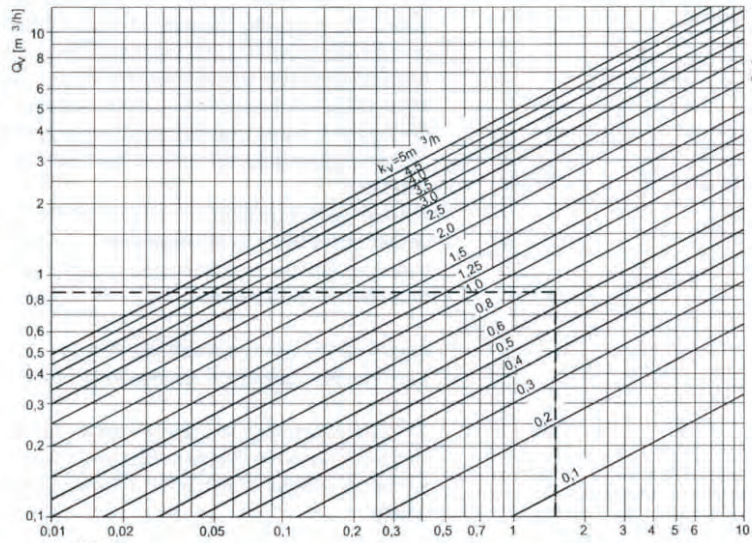

Fig. 2 Relation between water quantity and pressure drop across valve. Example: Flow $0.85 m^3/h$ with a pressure drop of 1.5 bar. The k_v value becomes $0.7 m^3/h$.

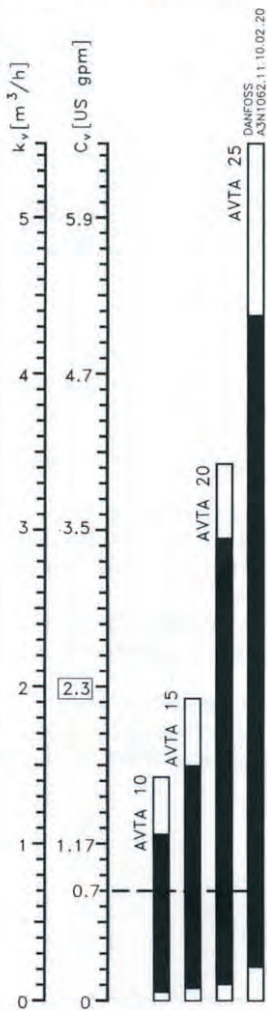

Fig. 3 Nomogram showing the valve k_v range. k_v values are always given for water flow in m^3/h with a pressure drop Δp of 1 bar. The valve should be selected so that the necessary k_v value lies in the middle of the regulation range. Example: AVTA 10 and 15 are the most suitable for a k_v value of 0.7

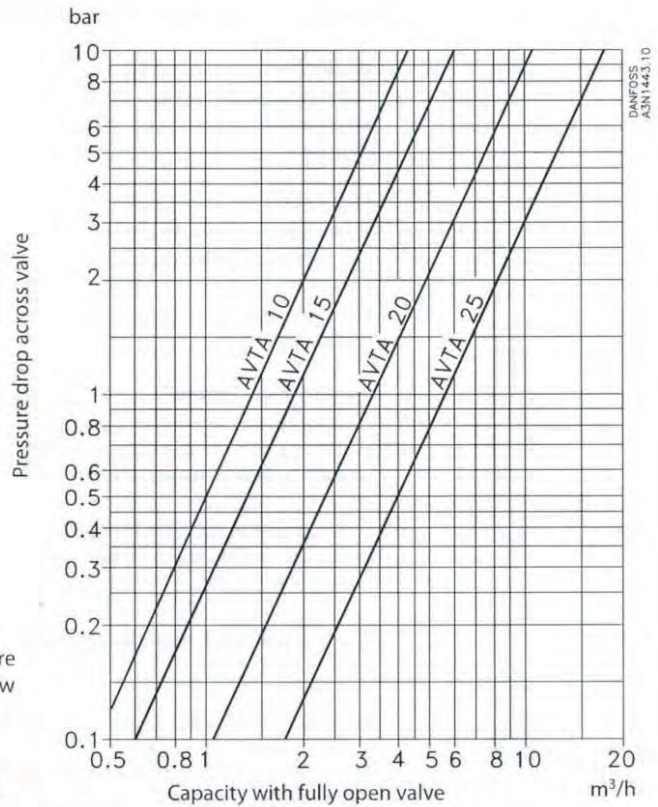

Fig. 4 Valve flow quantity in fully open position, as a function of pressure drop Δp .

Data sheet

Thermostatically operated cooling water valves Type AVTA

Options

- DZR brass
- Outer thread connecting
- Other lengths of capillary tubes
- Armouring of capillary tubes
- Other combinations of sizes, materials and ranges
- NPT - connection, see separate datasheet for USA / Canada